

Entanglement distillation between solid-state quantum network nodes

Norbert Kalb, A. A. Reiserer, P. C. Humphreys,
J. J. W. Bakermans, S. J. Kamerling, N. H. Nickerson,
S. C. Benjamin, D. J. Twitchen, M. Markham, R. Hanson



Our ambition: a first quantum internet



Collaboration between experimental physicists, theorists, material scientists, engineering support...

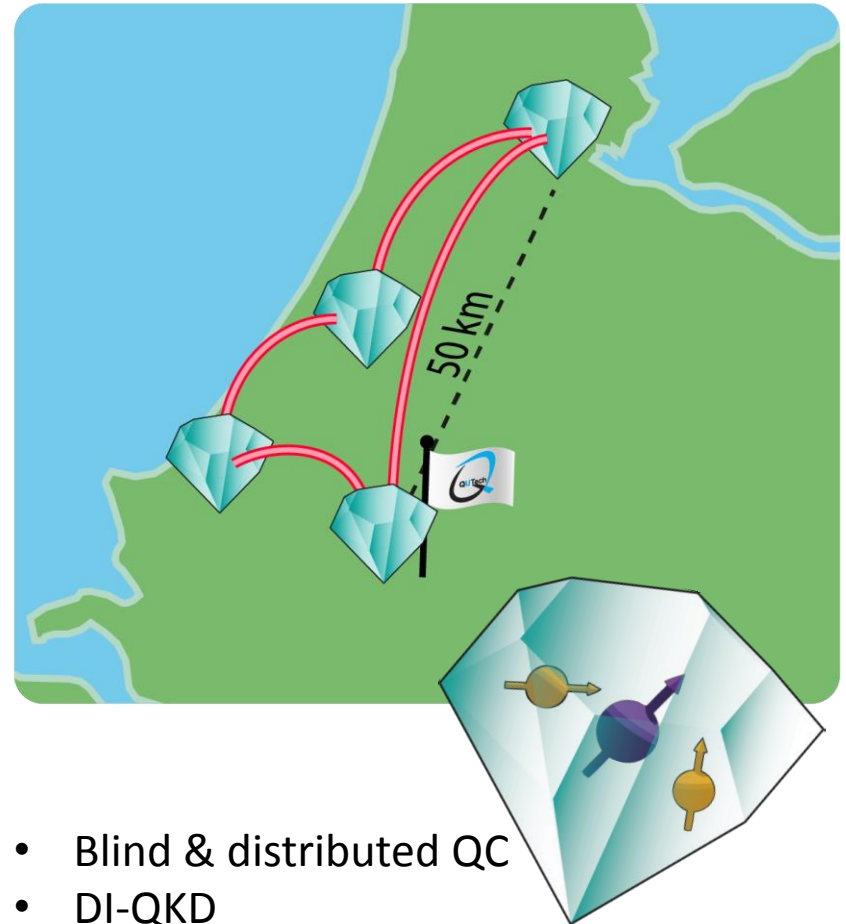

- Blind & distributed QC
- DI-QKD
- Metrology applications
- ...

A diamond-based quantum network

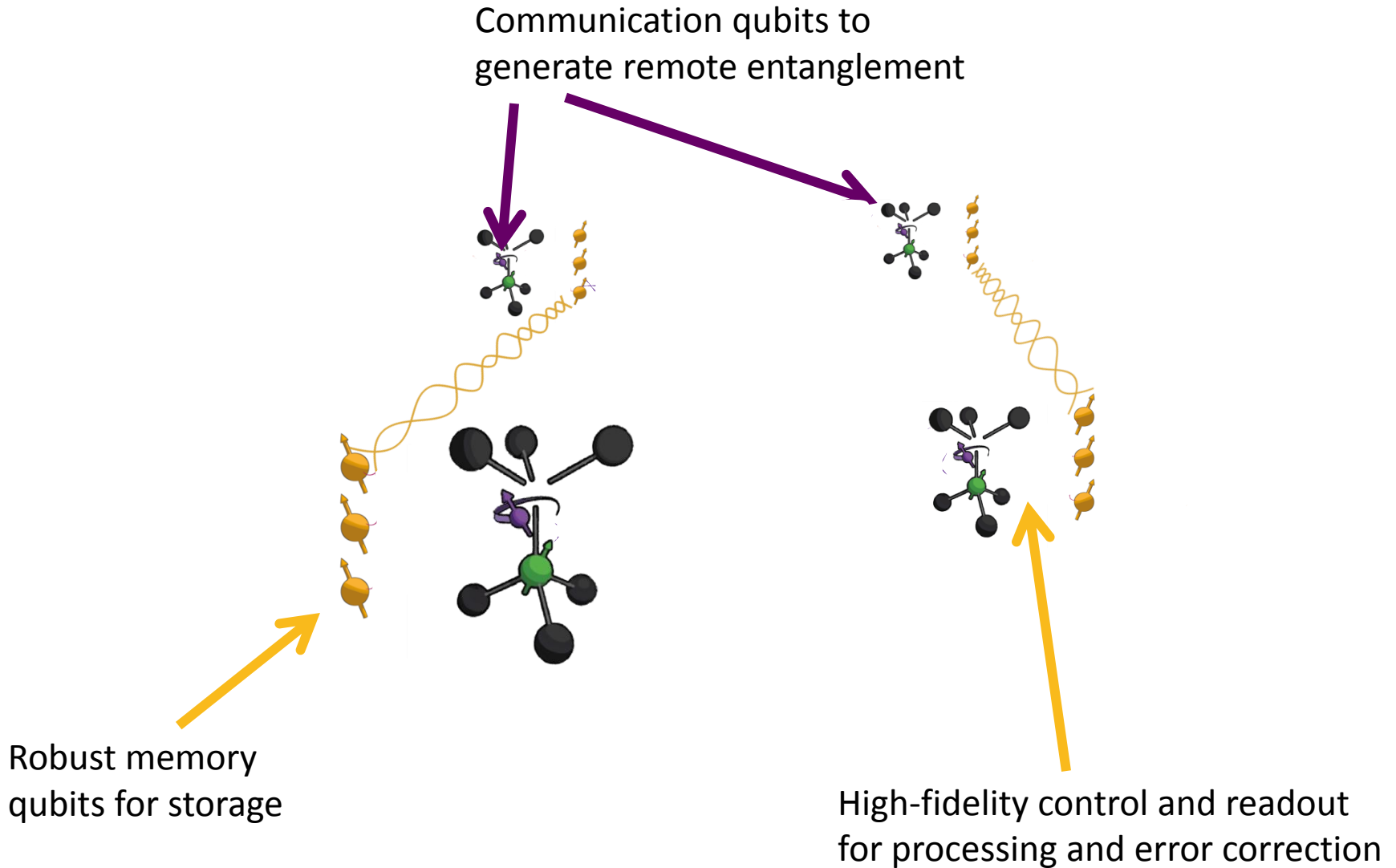

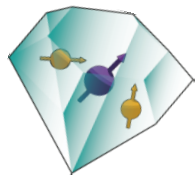

Why NV centres?

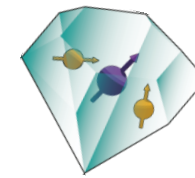

Optical interface

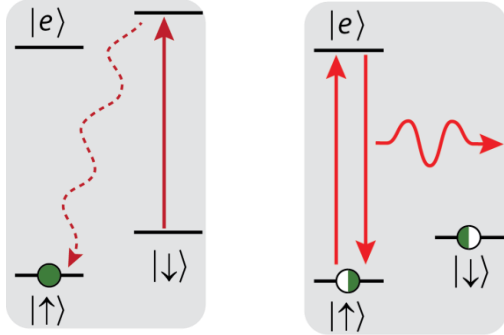

Nature 477 (2011)

Long coherence times ~ 1 s

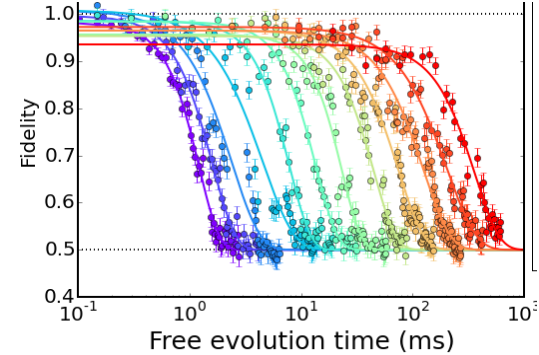

unpublished

Nuclear spin quantum register

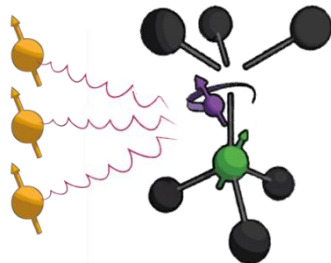

*Nat. Nano. 9 (2014); PRX (2016);
Nat. Commun. 7 (2016)*

Remote entanglement

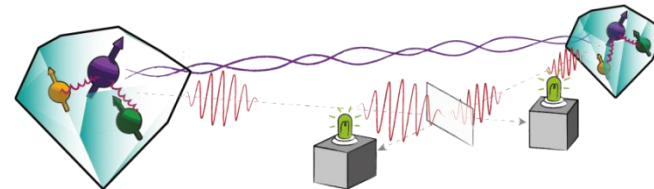

*Nature 497 (2013); Science 345(2014);
Nature 526 (2015); Scient. Rep. 6, 30289 (2016)*

Many related works by Stuttgart, Harvard, Chicago, Ulm,...

Diamond networks: A to-do list

Optical cavities:
expect rate x1000

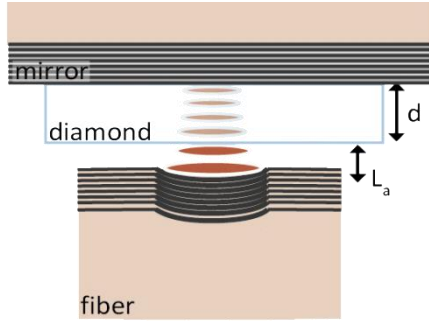

Maletinsky/Warburton
PRX 7, 031040 (2017)

Telecom wavelength conversion

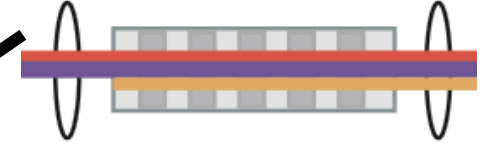

Zaske et al. PRL 109, 147404 (2012)

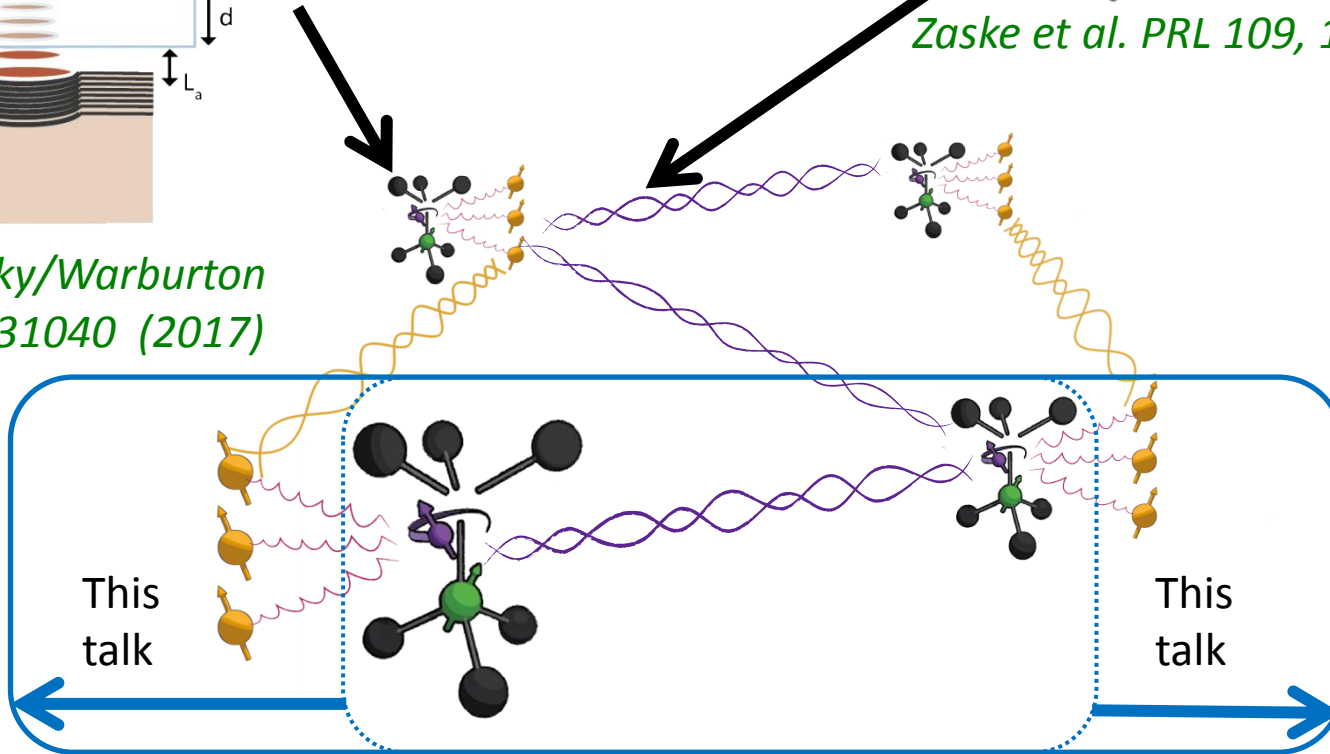

Wiring up the **ideal** quantum internet

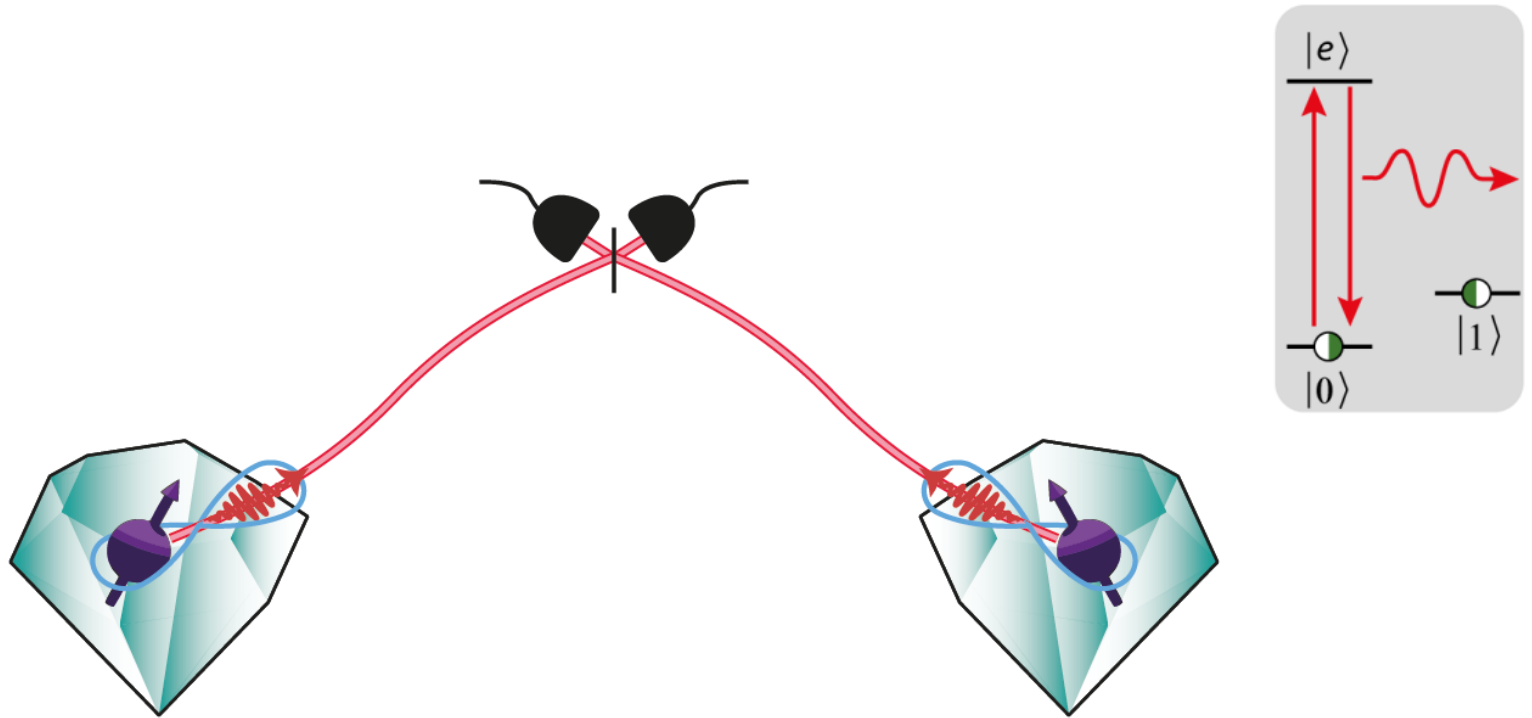

Wiring up the **ideal** quantum internet

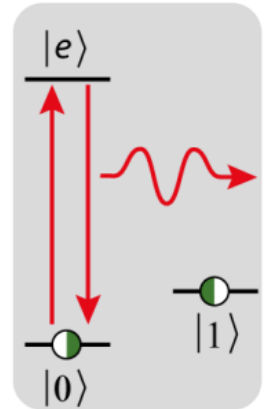
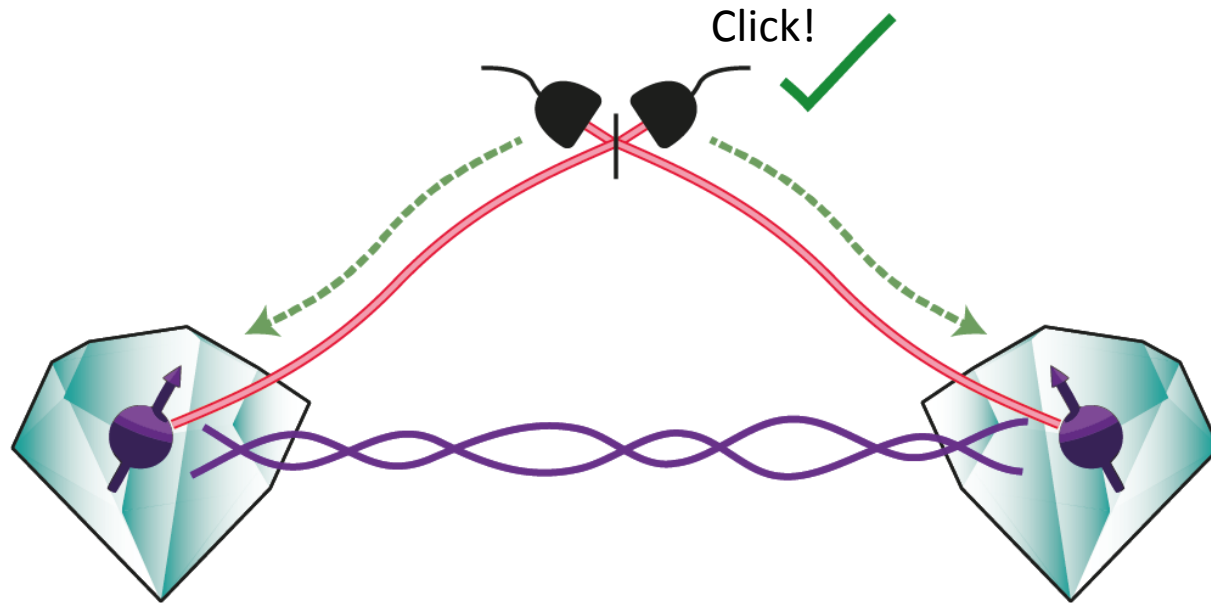

APD CLICK $\rightarrow \frac{1}{\sqrt{2}} (|0, 1\rangle + |1, 0\rangle) \equiv |\Psi^+\rangle$

Wiring up the **real** quantum internet

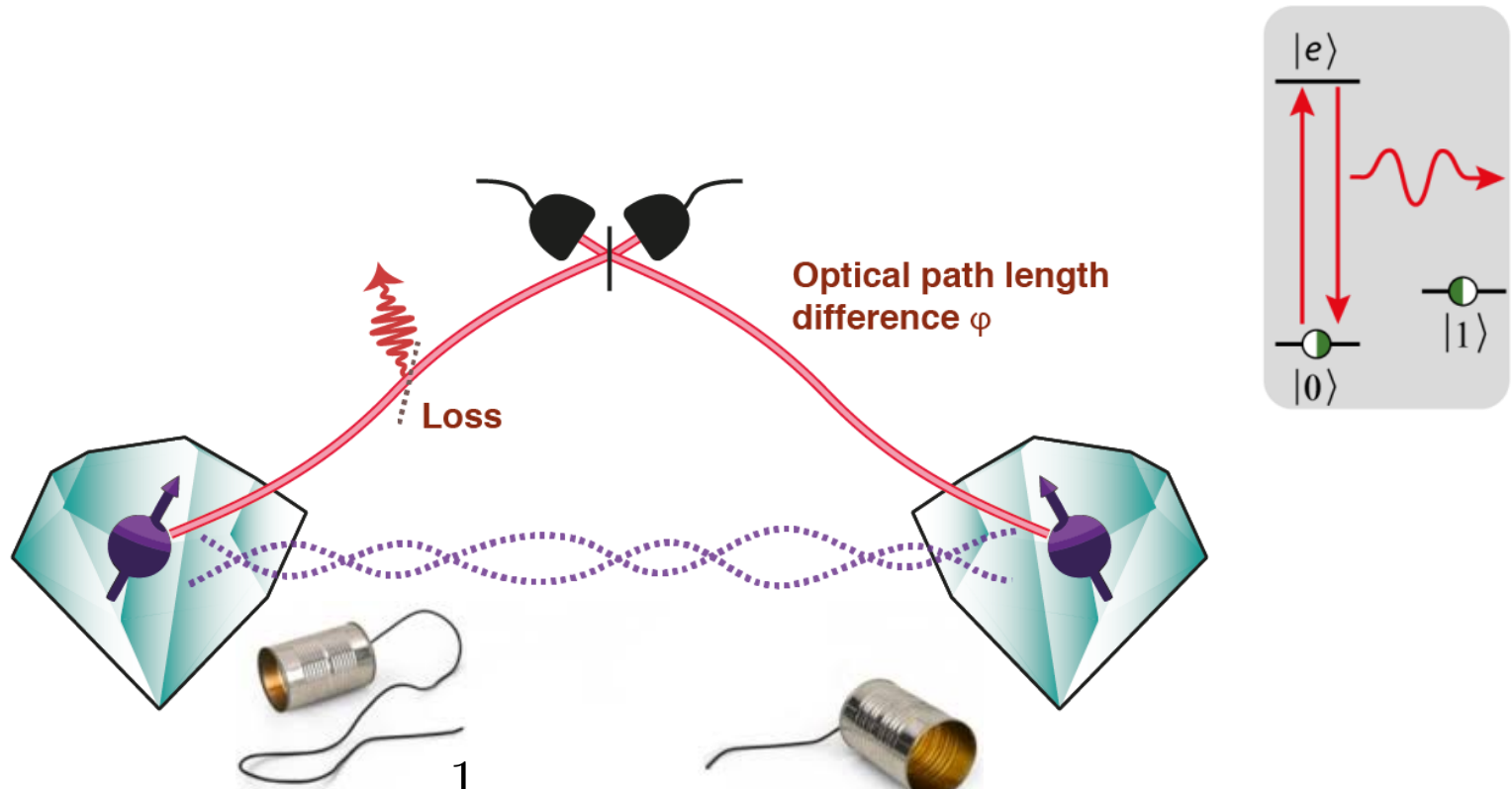

APD CLICK $\rightarrow \frac{1}{\sqrt{2}} (|0, 1\rangle + |1, 0\rangle) \equiv |\Psi^+\rangle$

APD CLICK $\rightarrow \frac{1}{2} |\Psi_\phi^+\rangle \langle \Psi_\phi^+| + \frac{1}{2} |0, 0\rangle \langle 0, 0|$

Phase dependent Mixed state
due to loss

Overcoming imperfections: The distillery

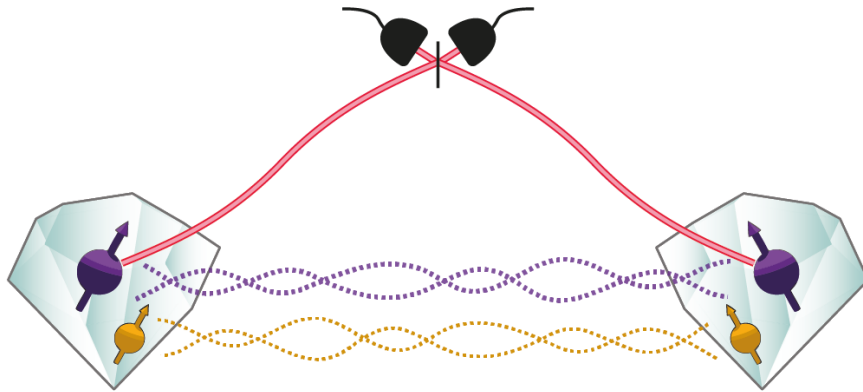

≡



Entanglement Distillation



$$2 \times \left(\frac{1}{2} |\Psi_{\phi}^{+}\rangle \langle \Psi_{\phi}^{+}| + \frac{1}{2} |0, 0\rangle \langle 0, 0| \right) \rightarrow |\Psi_0^{+}\rangle \langle \Psi_0^{+}|$$

Phase dependent Mixed state



We use: Campbell & Benjamin, PRL **101**, 130502 (2008)

Initial protocols: Bennett et al., PRL (1996); Deutsch et al., PRL (1996)

Always-on interactions

Entanglement
generation
sequence

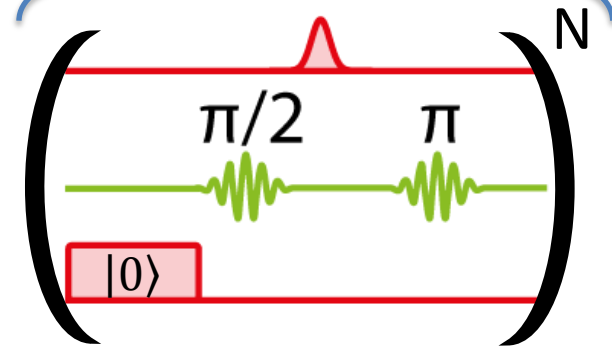
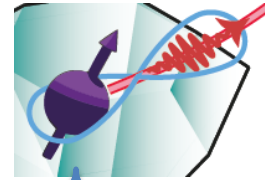

Nuclear spin quantum register

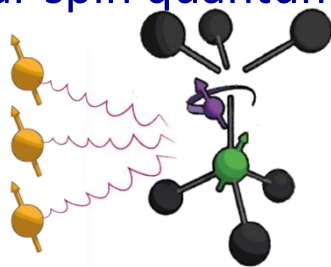

Remote entanglement

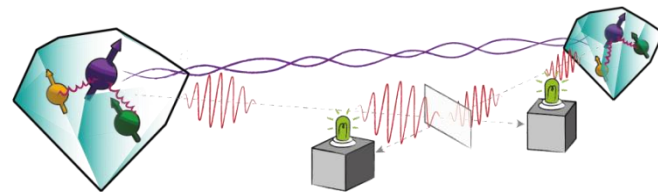

Always-on interactions

State dependent frequency of the nuclear spin memory

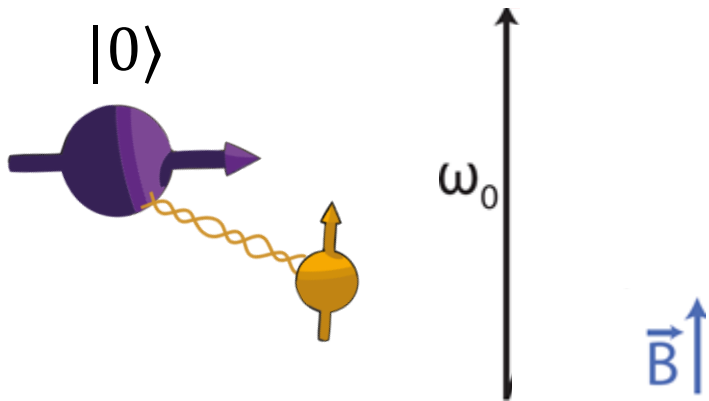

Entanglement generation sequence

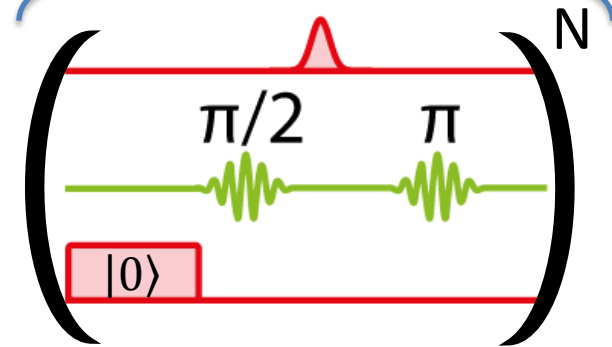
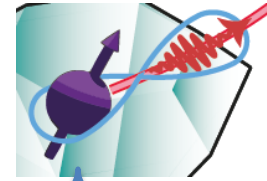

Nuclear spin quantum register

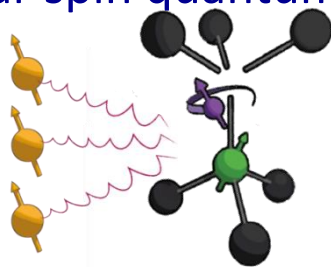

Remote entanglement

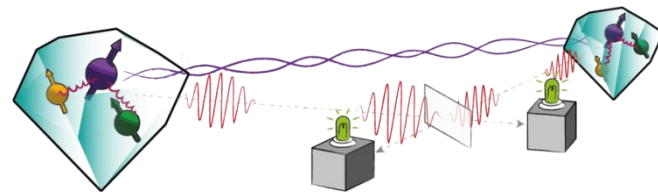

Always-on interactions

State dependent frequency of the nuclear spin memory

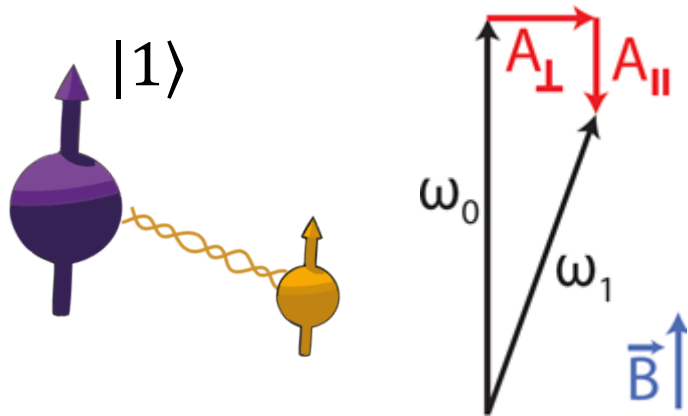

Entanglement generation sequence

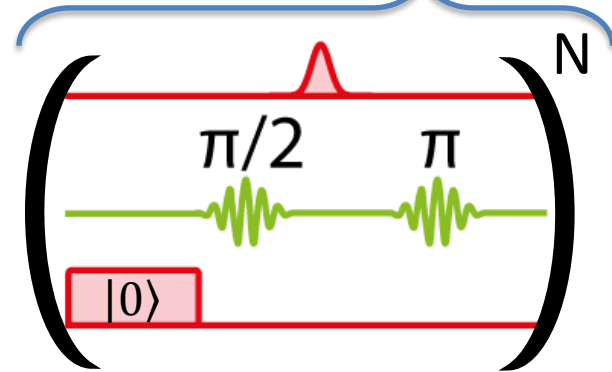
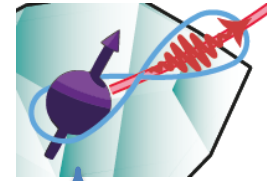

Nuclear spin quantum register

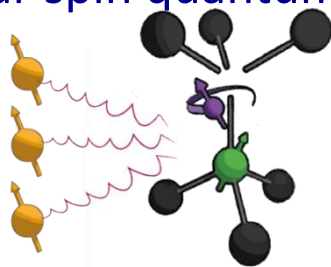

Remote entanglement

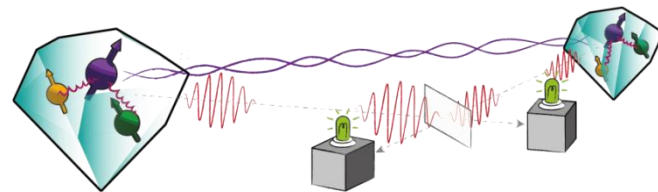

Always-on interactions

State dependent frequency of the nuclear spin memory

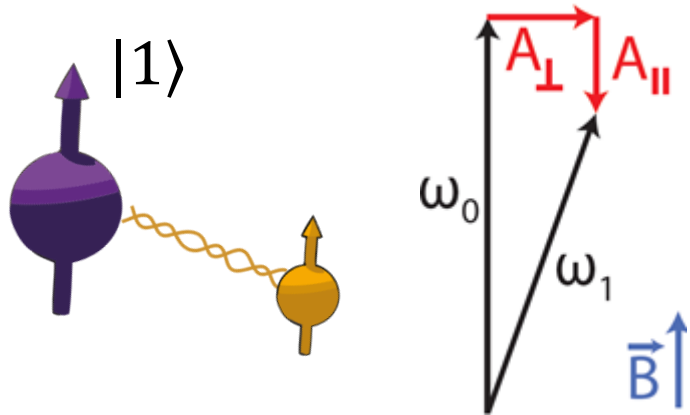

Entanglement generation sequence

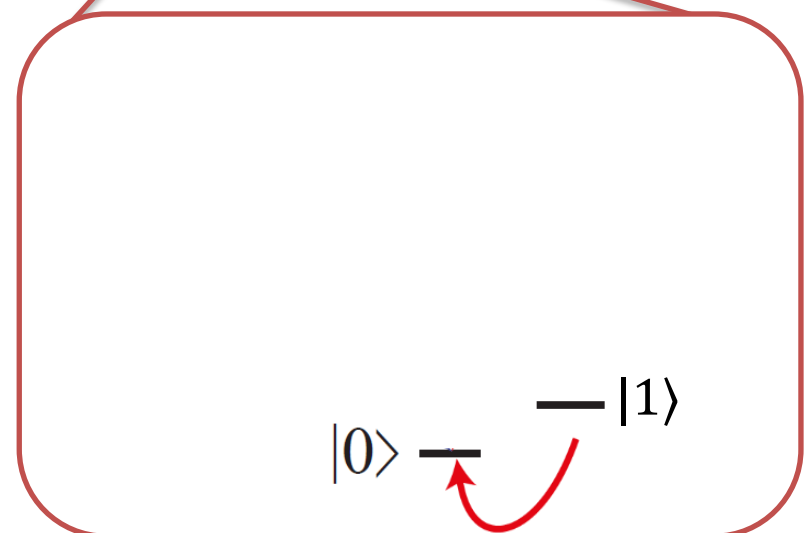
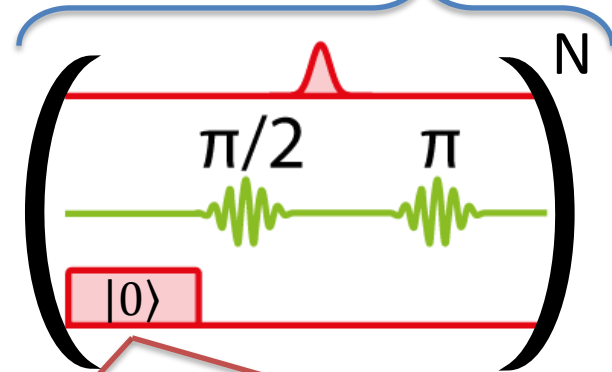
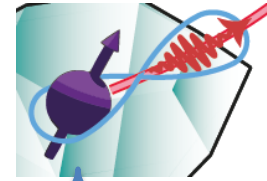

Always-on interactions

State dependent frequency of the nuclear spin memory

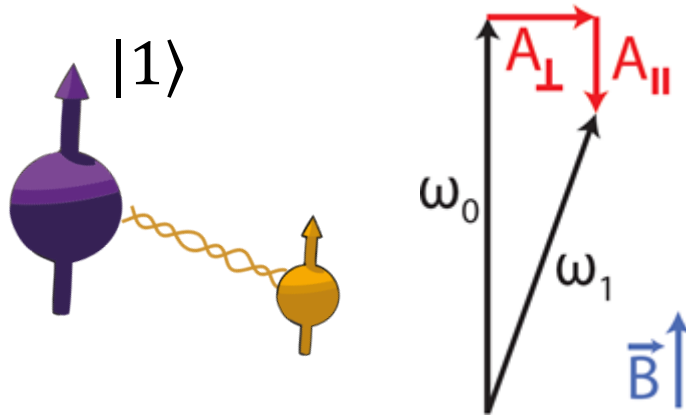

Reinitialization:
Complicated and probabilistic evolution
NV occupies spin states randomly

→ Causes nuclear dephasing

Entanglement generation sequence

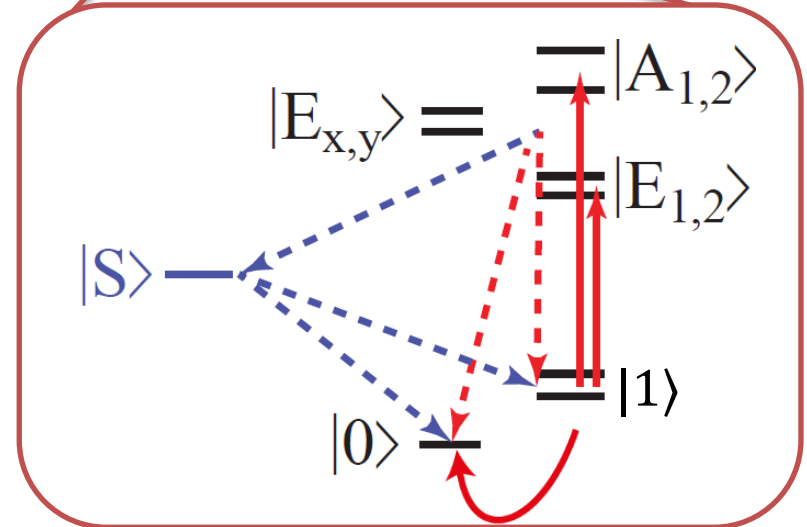
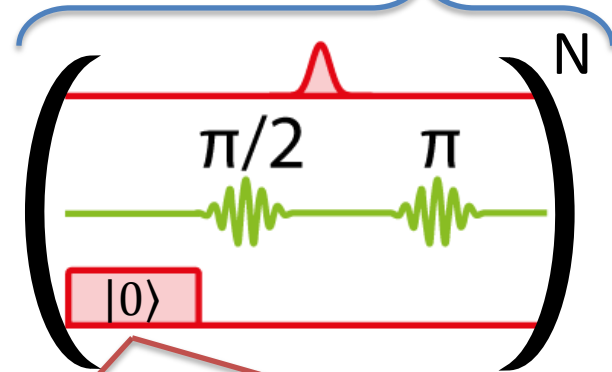
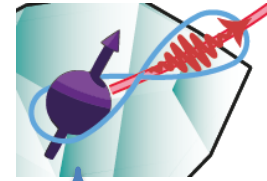

Always-on interactions

State dependent frequency of the nuclear spin memory

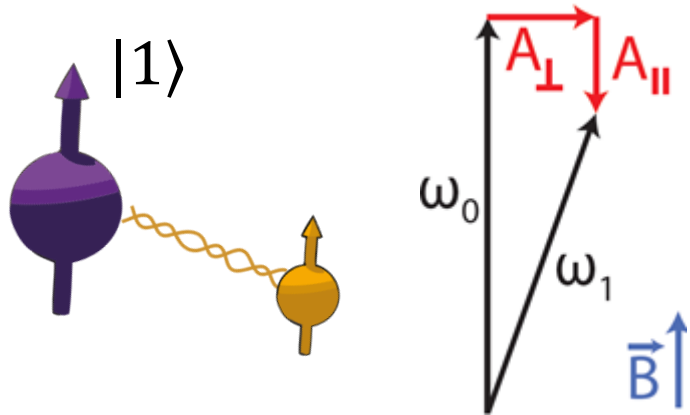

Entanglement generation sequence

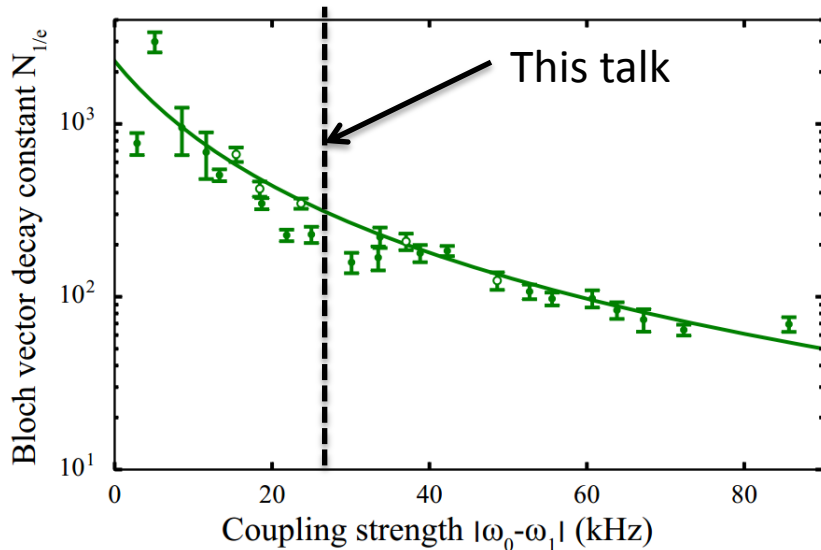
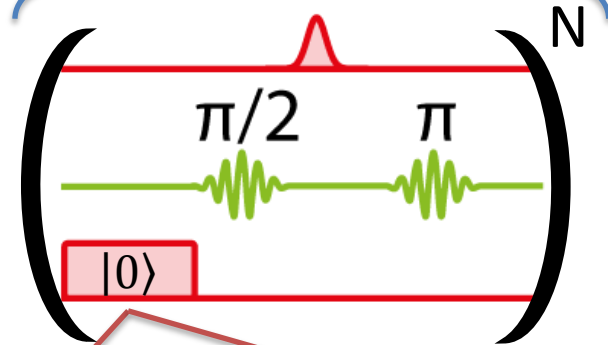
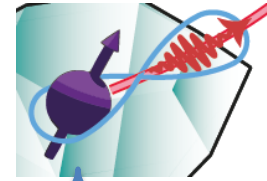

Reiserer*, NK*, et al., PRX 6, 021040 (2016)

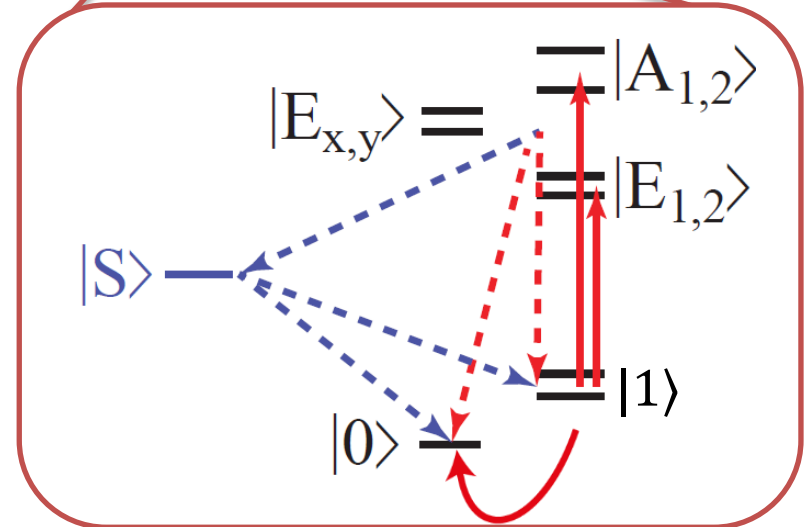

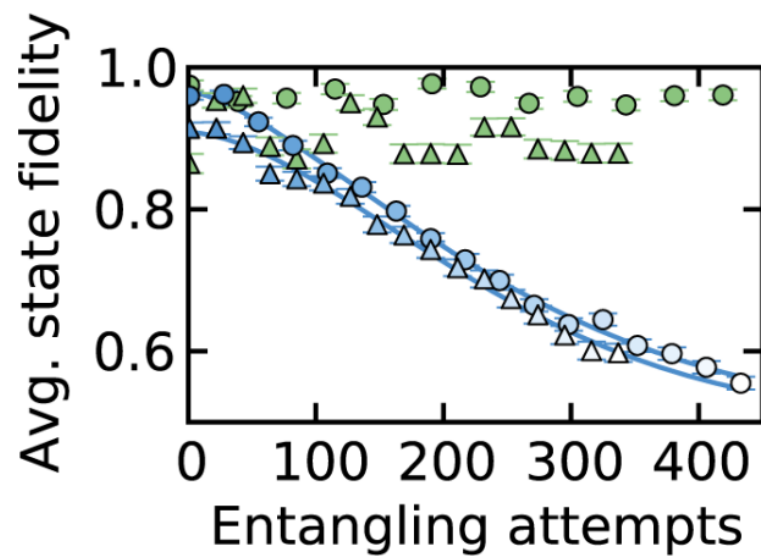
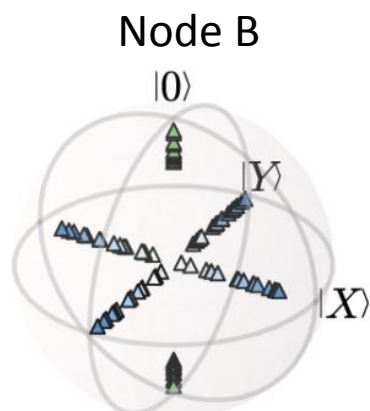
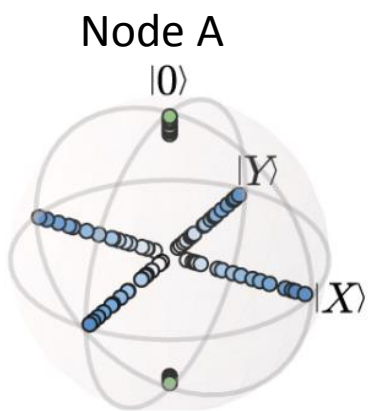
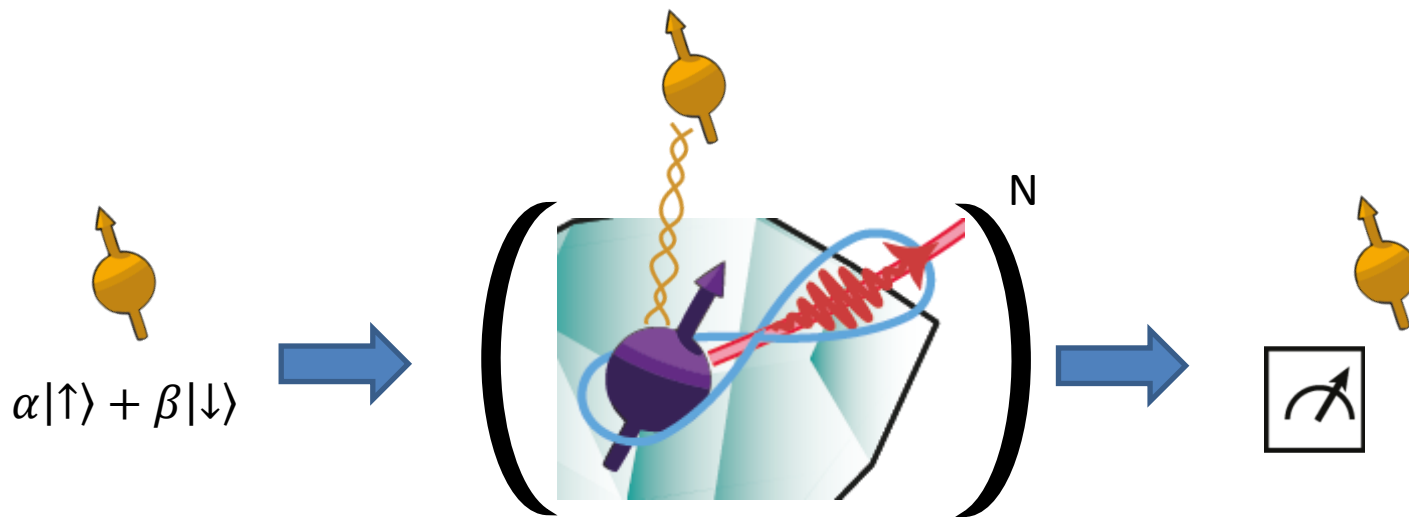

Distillation experiment

Science 356, 928 (2017)

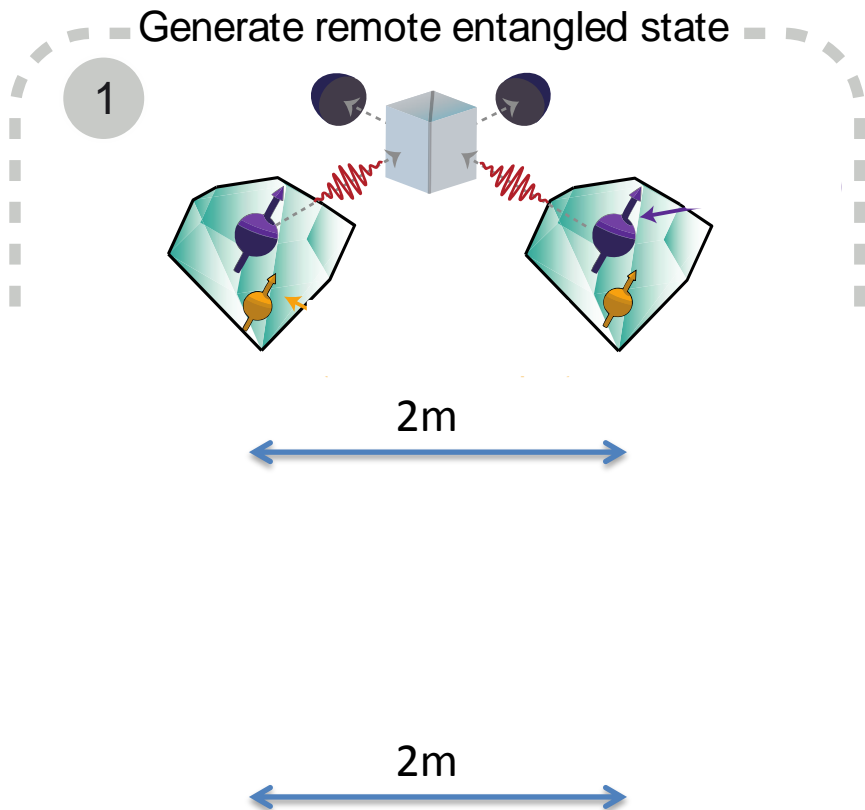
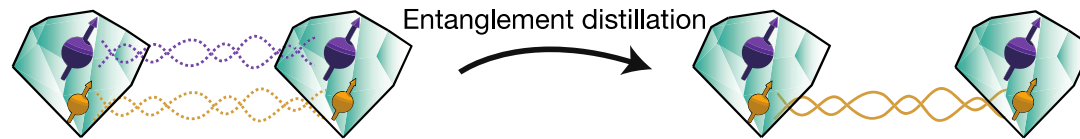

Distillation experiment

Science 356, 928 (2017)

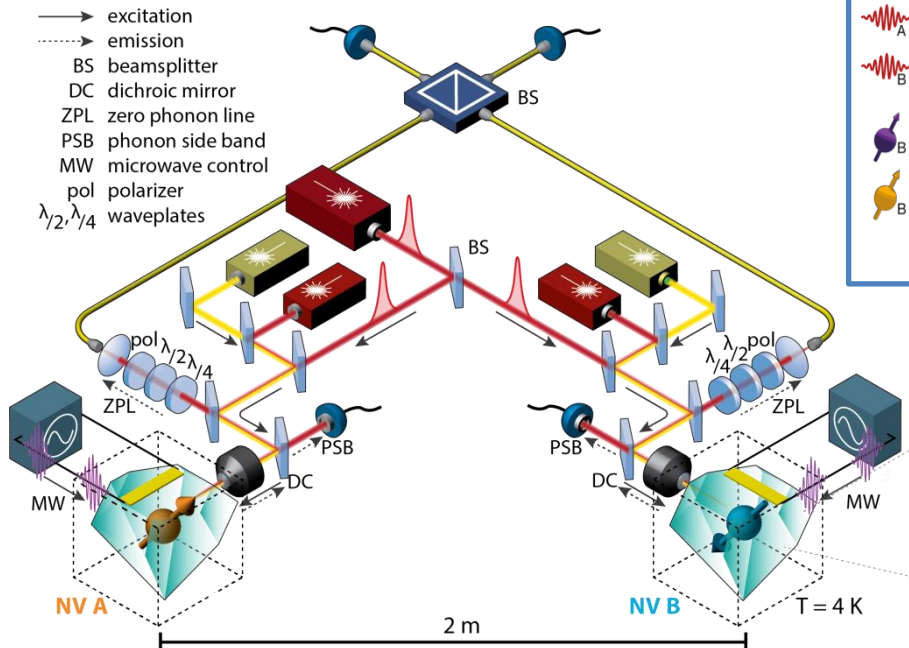
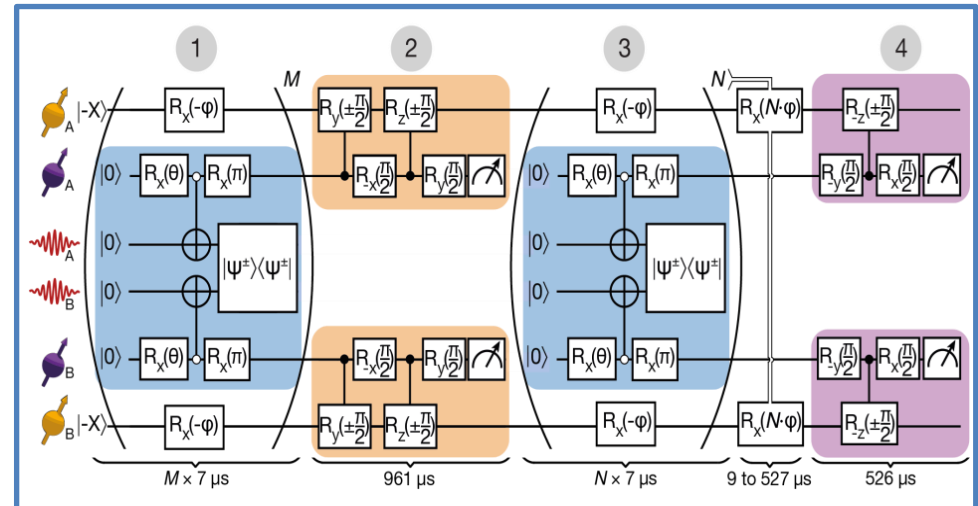
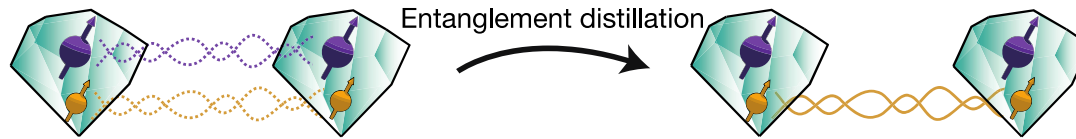

Distillation experiment

Science 356, 928 (2017)

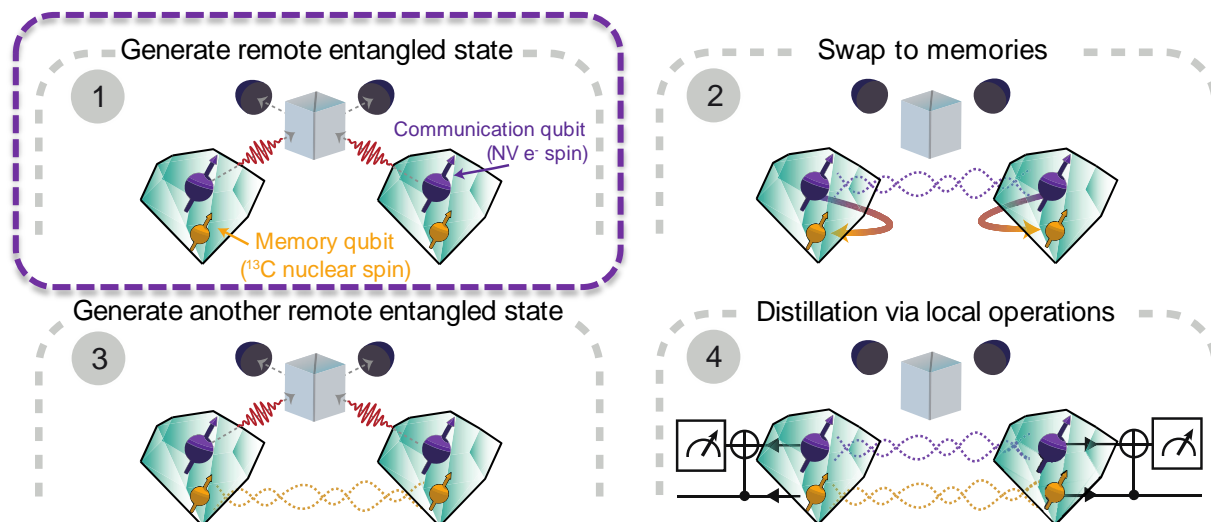

Raw state is of the form:

$$(1 - \alpha)|\Psi_{\phi}^{\pm}\rangle\langle\Psi_{\phi}^{\pm}| + \alpha|0,0\rangle\langle 0,0|$$

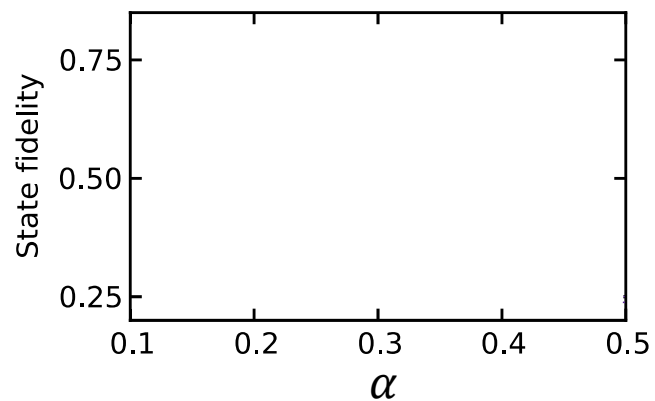

Distillation experiment

Science 356, 928 (2017)

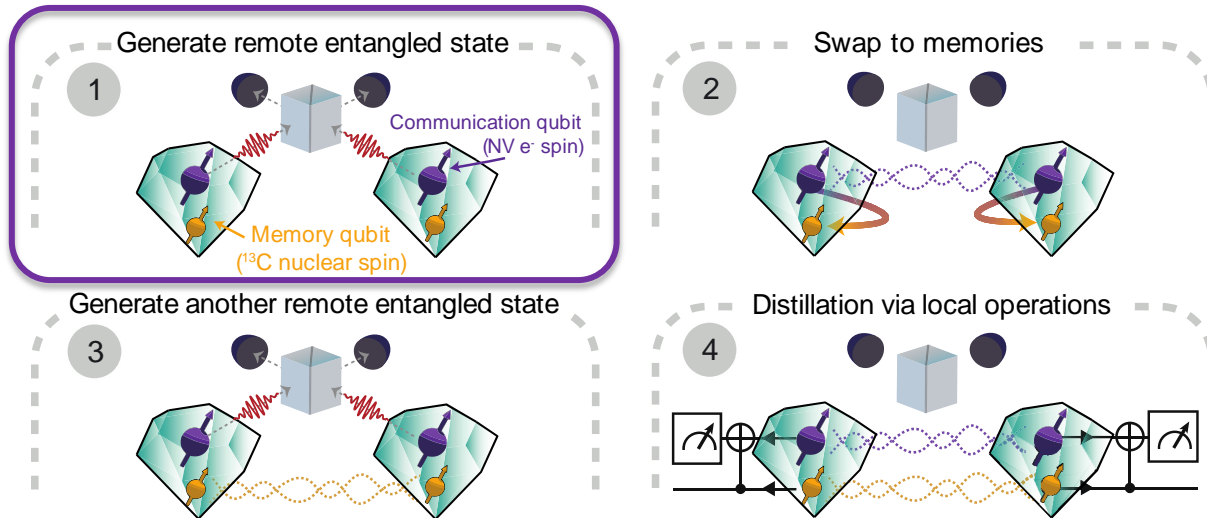

Raw state is of the form:

$$(1 - \alpha)|\Psi_{\phi}^{\pm}\rangle\langle\Psi_{\phi}^{\pm}| + \alpha|0,0\rangle\langle 0,0|$$

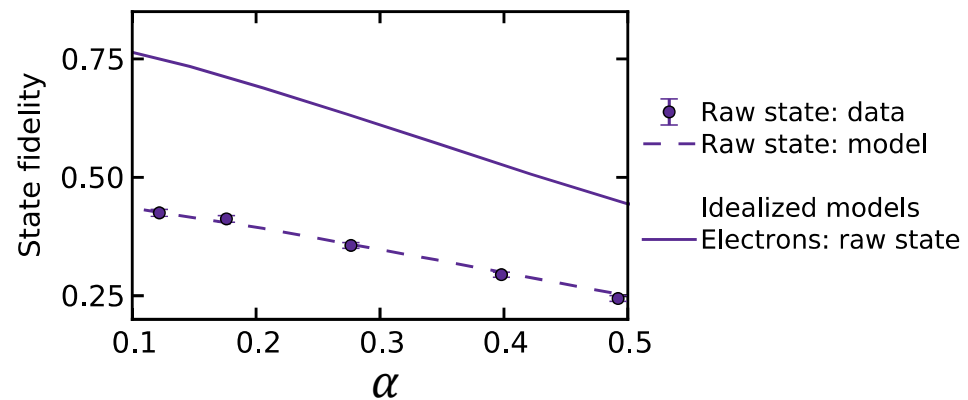

Distillation experiment

Science 356, 928 (2017)

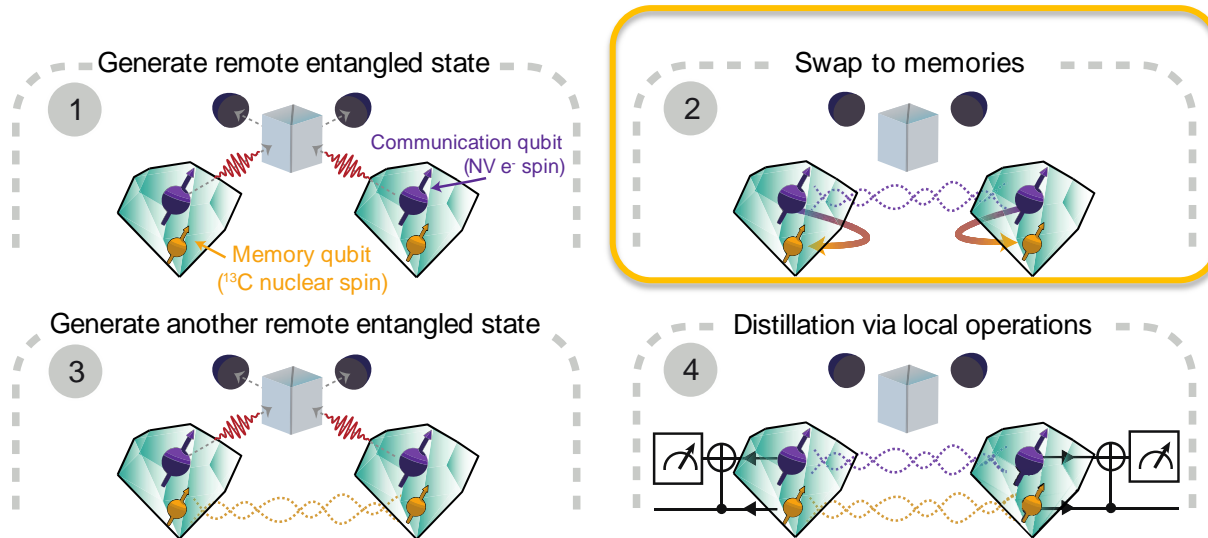

Raw state is of the form:

$$(1 - \alpha)|\Psi_{\phi}^{\pm}\rangle\langle\Psi_{\phi}^{\pm}| + \alpha|0,0\rangle\langle 0,0|$$

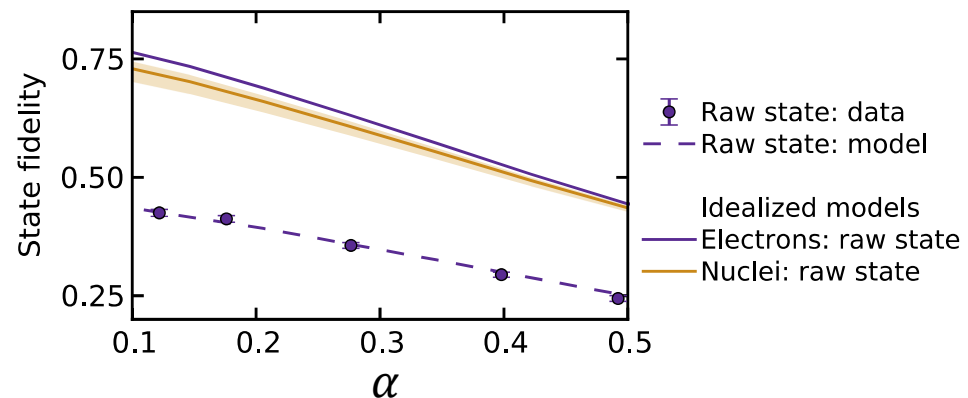

Distillation experiment

Science 356, 928 (2017)

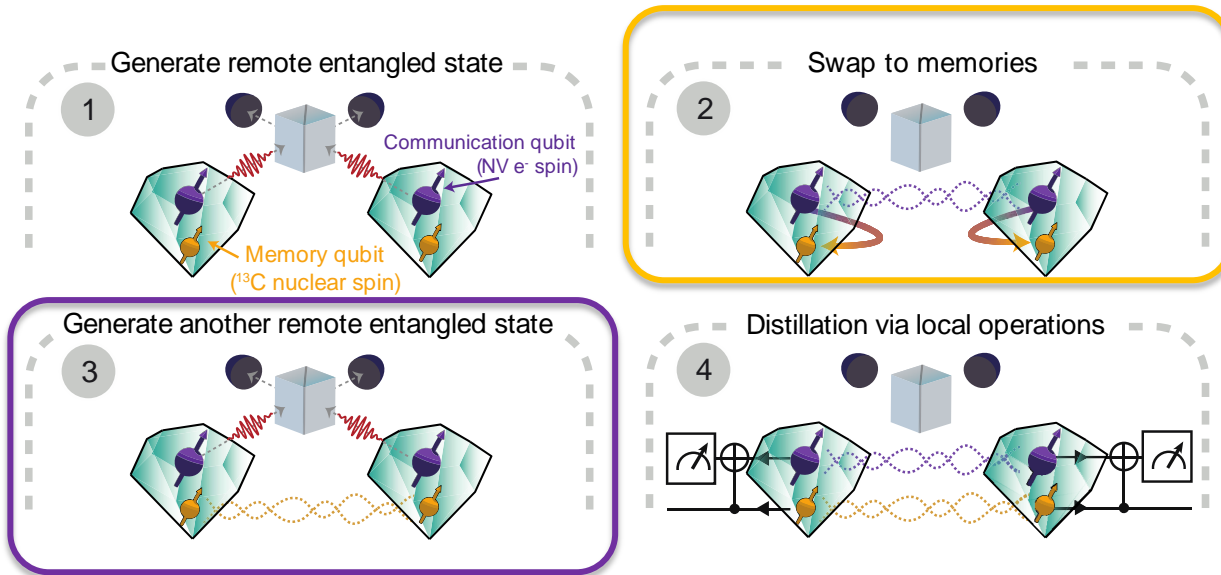

Raw state is of the form:

$$(1 - \alpha)|\Psi_{\phi}^{\pm}\rangle\langle\Psi_{\phi}^{\pm}| + \alpha|0,0\rangle\langle 0,0|$$

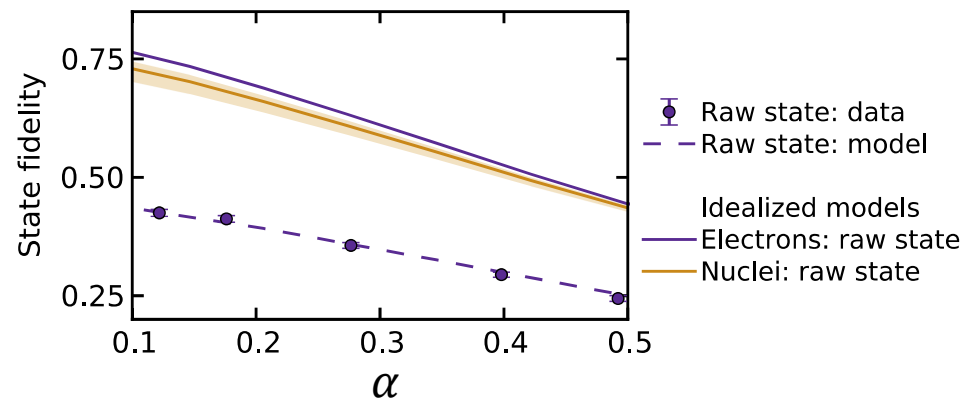

Distillation experiment

Science 356, 928 (2017)

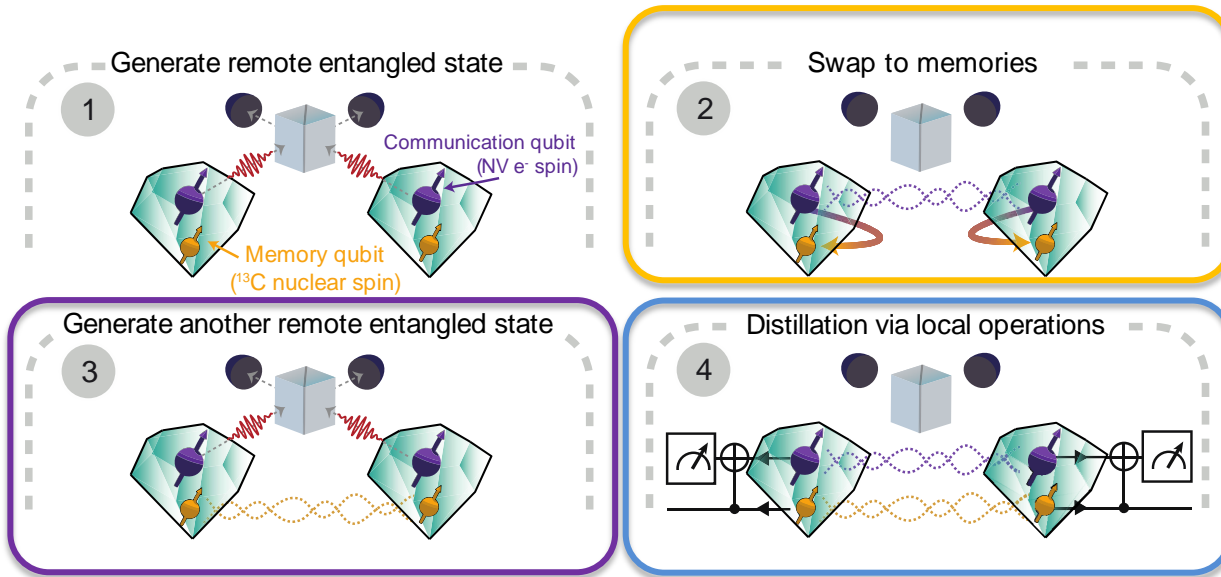

Raw state is of the form:

$$(1 - \alpha)|\Psi_{\phi}^{\pm}\rangle\langle\Psi_{\phi}^{\pm}| + \alpha|0,0\rangle\langle 0,0|$$

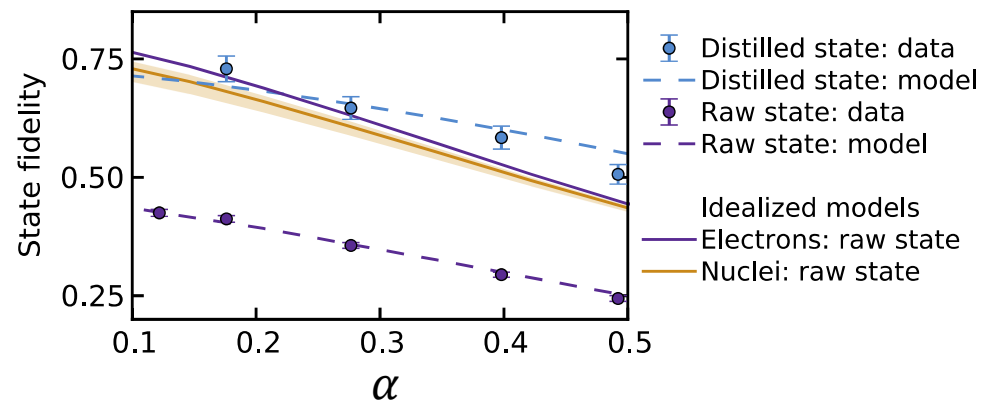

Deterministic entanglement generation

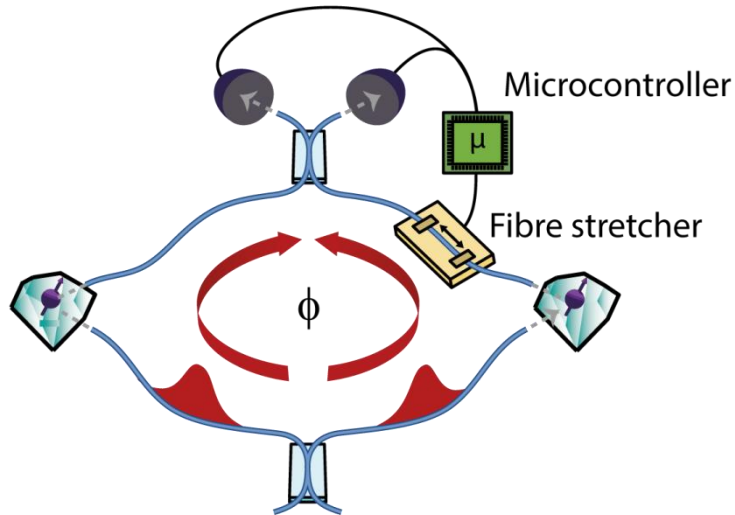

Measure and correct internal phase
Vastly increased entangling rate (40 Hz)!

$$(1 - \alpha)|\Psi_0^\pm\rangle\langle\Psi_0^\pm| + \alpha|0,0\rangle\langle 0,0|$$

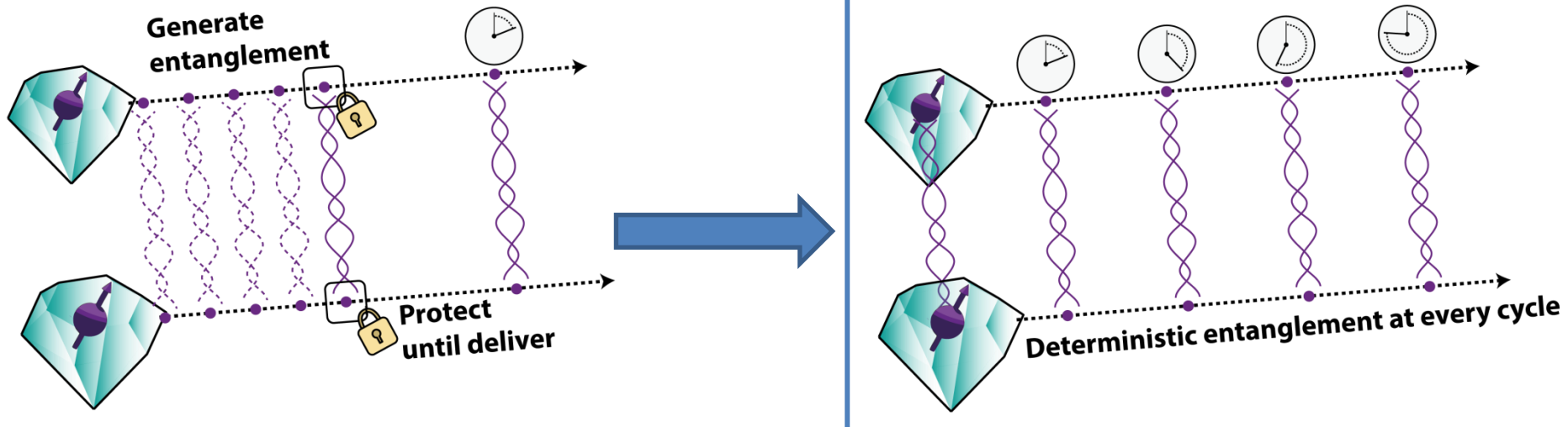

P. Humphreys, NK et al., in preparation

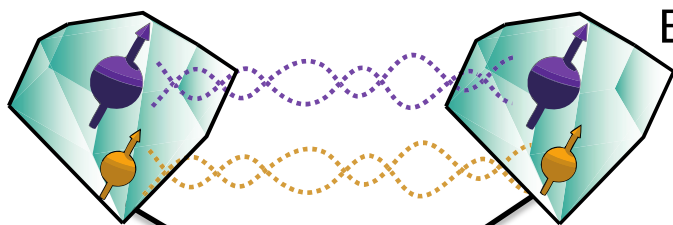
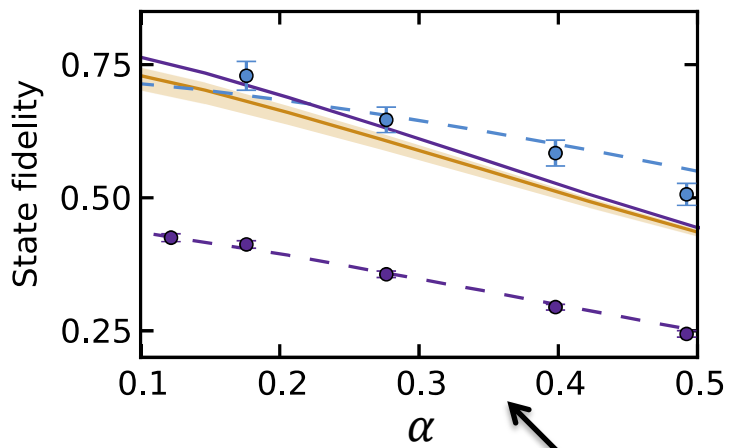

Entanglement distillation

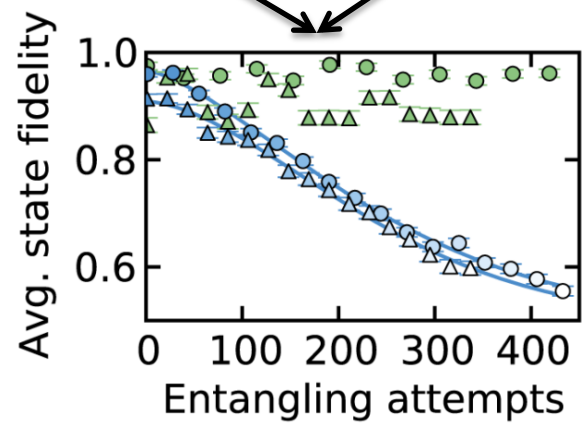
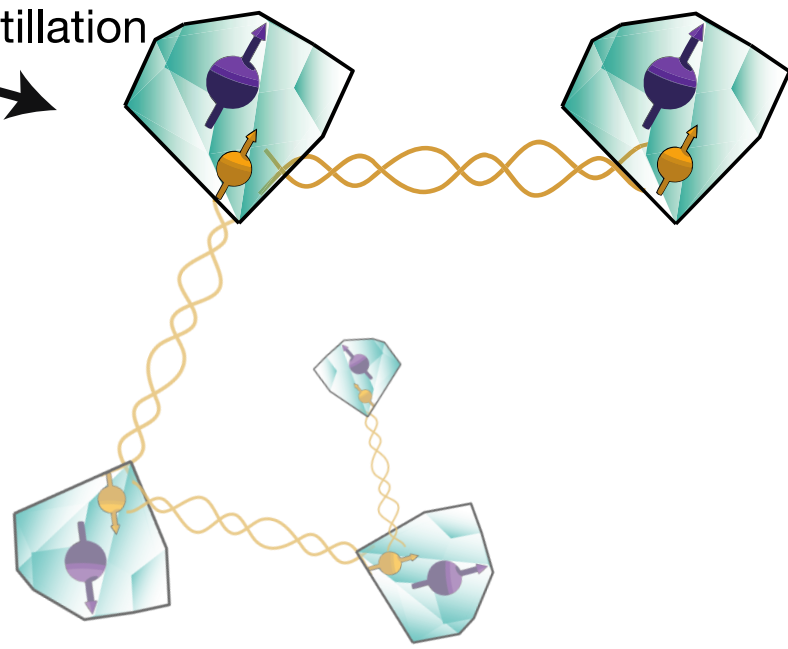

NK et al., Science 356, 928 (2017)

