

High-rate QKD with silicon photonics

Likang Zhang*, Wei Li*, Hao Tan, Yan-Lin Tang, Kejin Wei

Sheng-Kai Liao, Cheng-Zhi Peng, Feihu Xu and Jian-Wei Pan

National Laboratory for Physical Sciences at the Microscale
University of Science and Technology of China (USTC)



Chip-based QKD

Challenges in Practical QKD

Expensive (Lasers, high-bandwidth modulators, single photon detectors)

Large-scale and Heavy

Solution: Integrated platform

1. Low cost: mass manufacture
2. Integrated and Miniaturized

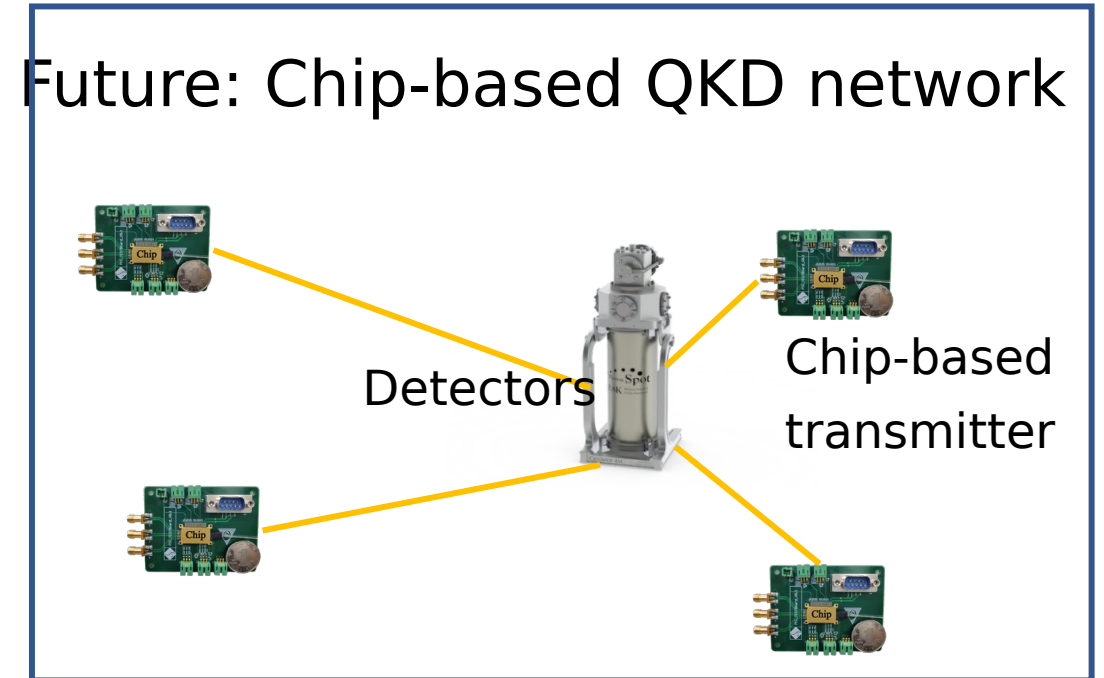

Integration is inevitable for future developments !

Recent works in chip-based

QKD

First Si QKD transmitter

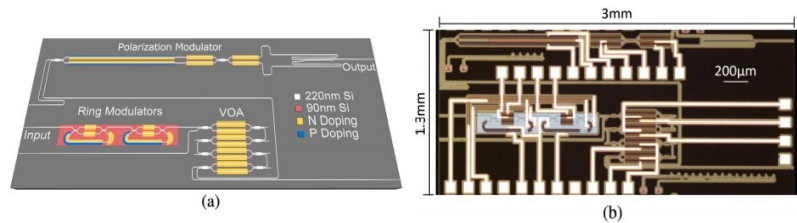

C. Ma et al., *Optica* 3, 1274 (2016)

High-speed modulation

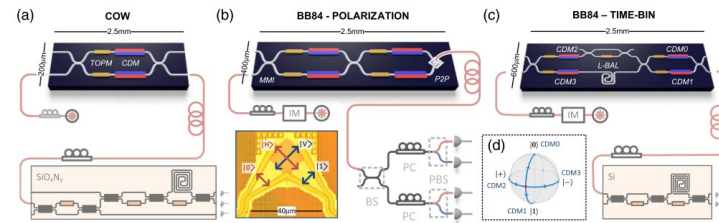

P. Sibson et al., *Optica* 4, 172 (2017)

High-dimensional protocol

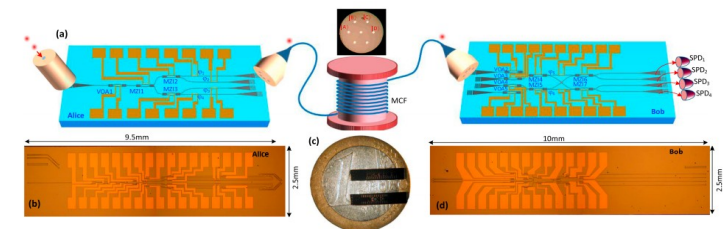

Y. Ding et al., *npj Quantum Inf.* 3, 25 (2017)

First InP QKD transmitter

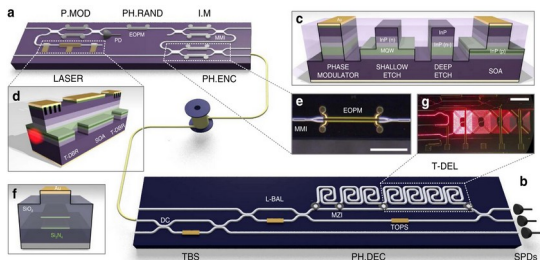

P. Sibson et al., *Nat. Commun.* 8, 13984 (2017)

Metropolitan field test

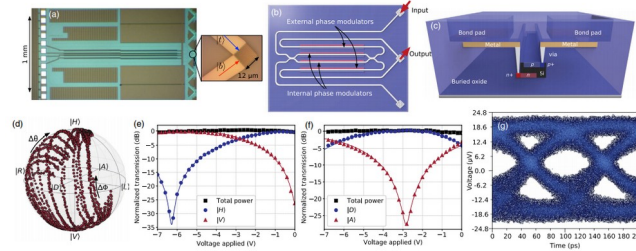

D. Bunandar et al., *PRX* 8, 021009 (2018)

On Si

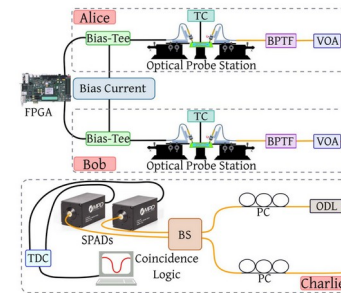

C. Agnesi et al., *Optics Letters* 2, 44 (2019)

On InP

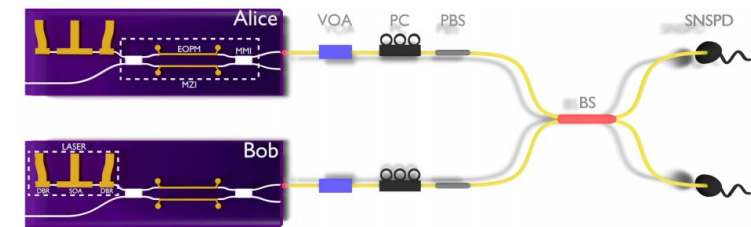

H. Semenenko et al., *Optics Letters* 2, 44 (2019)

CV-QKD integrated system

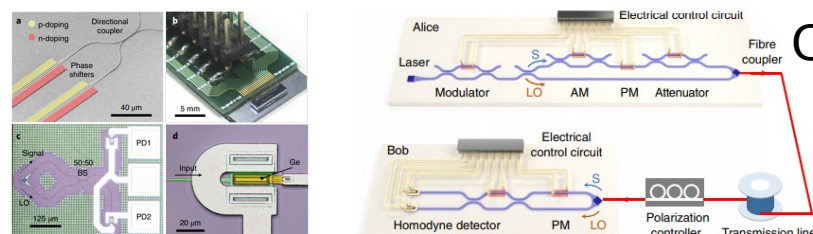

G. Zhang et al., *Nat. Photonics* 13, 839 (2019)

Modulator free transmitter

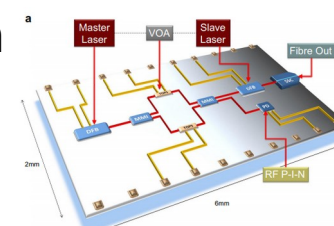

T. K. Paraiso et al., *npj Quantum Inf.* 5, 42(2019)

Challenges in chip-based QKD

- Mediocre **secure key rate**
- Low extinction ratio under high-speed modulation
- Stability

How to achieve higher key rates?

High Clock Rate

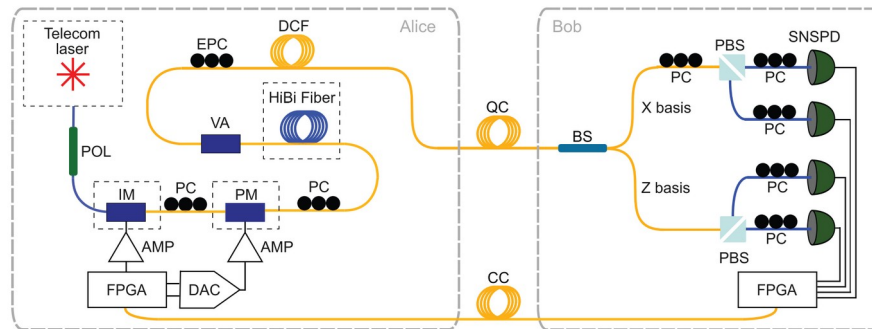

F. Grünenfelder et al., *Appl. Phys. Lett.* 117, 144003 (2020).

Low Quantum bit error rate

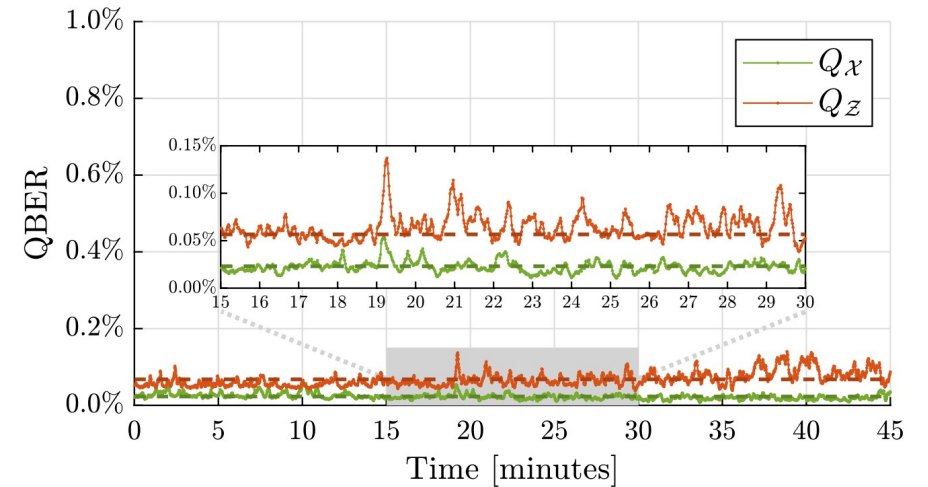

C. Agnesi et al., *Optica* 7, 4 (2020)

Setup

- 1-decoy 4-state efficient BB84 protocol
- 2.5 GHz random modulation
- 0.49% QBER, Two-stage polarization modulation
- Chip: commercially fabricated, integrated :
 - Intensity modulator(IM)
 - Polarization modulator(POLM)
 - Variable attenuator(ATT)
 - $4.8 \times 3\text{mm}^2$
- WDM: time synchronization

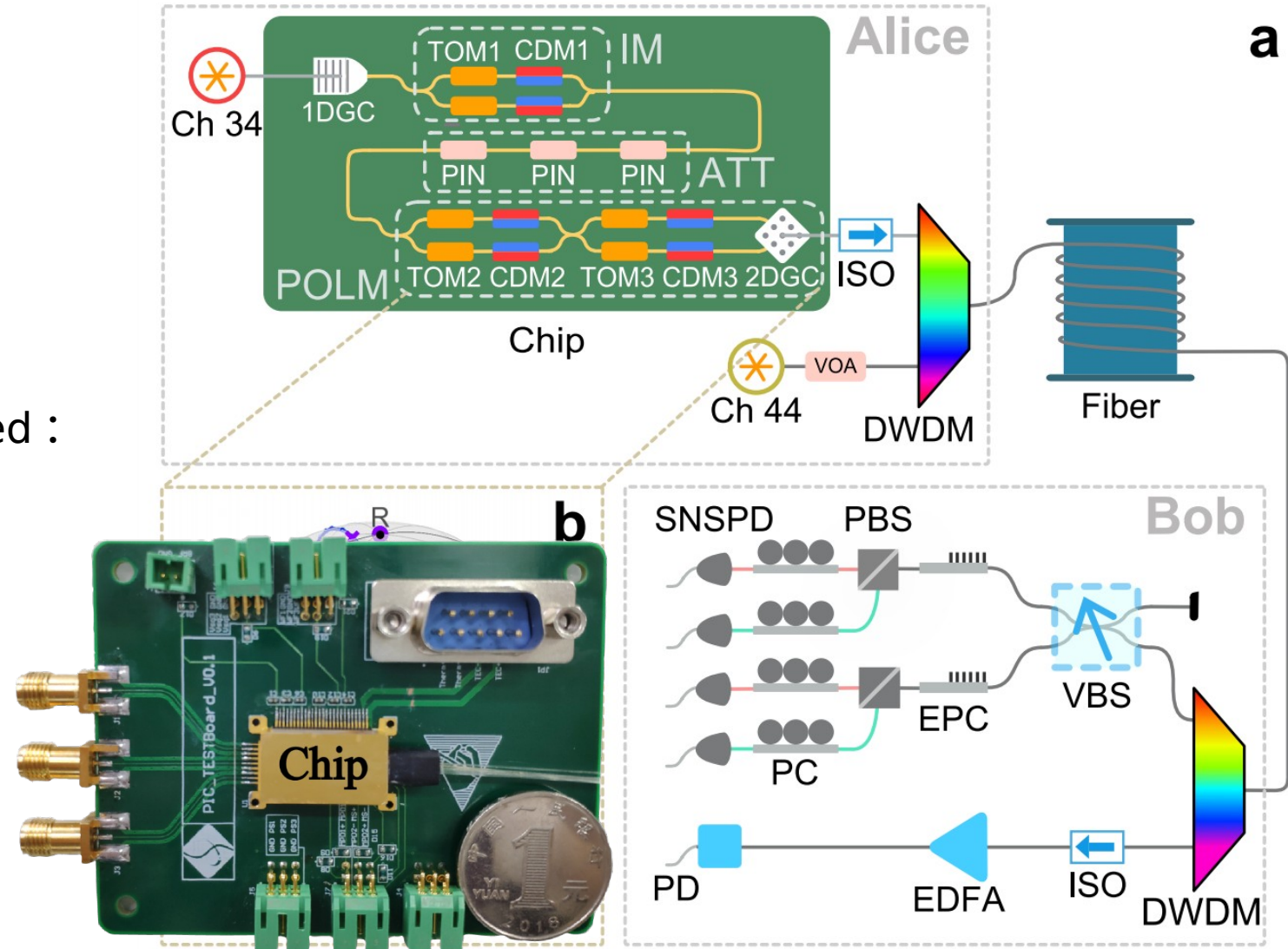

Polarization modulation method

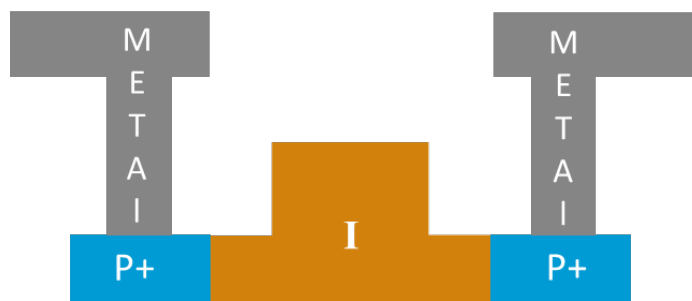
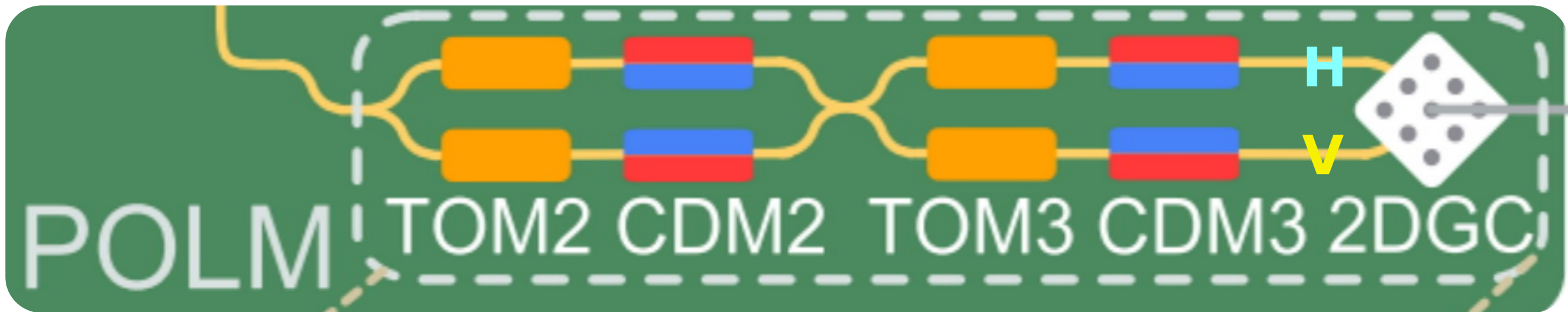

TOM(Thermo-Optic Modulator) CDM(Carrier Depletion Modulator)

Thermo-optic effect

Bandwidth \sim kHz, $V_{II} \sim$ 1V

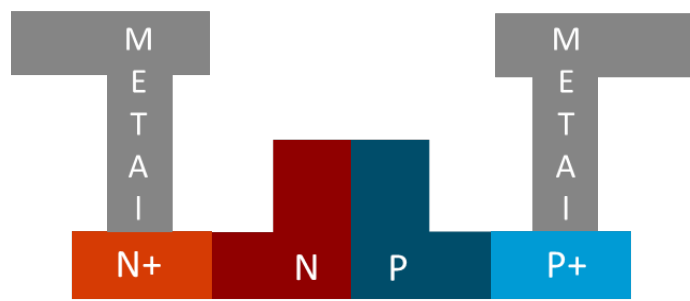

Plasma dispersion effect

Bandwidth \sim GHz, $V_{II} \sim$ 5V

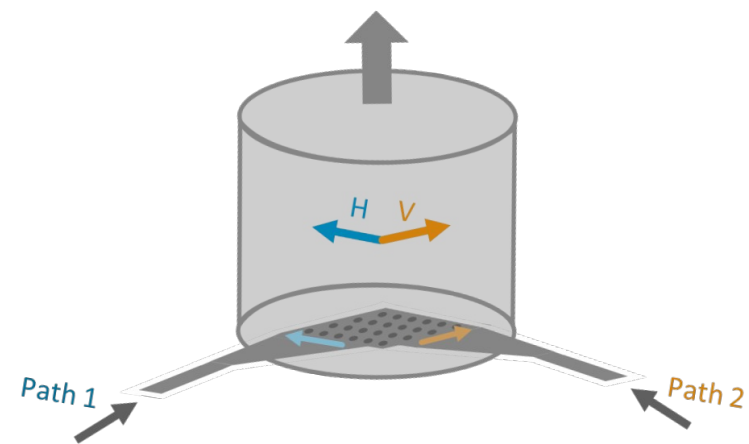

2DGC(2-Dimensional Grating Coupler)

Path to polarization converter

Polarization modulation method

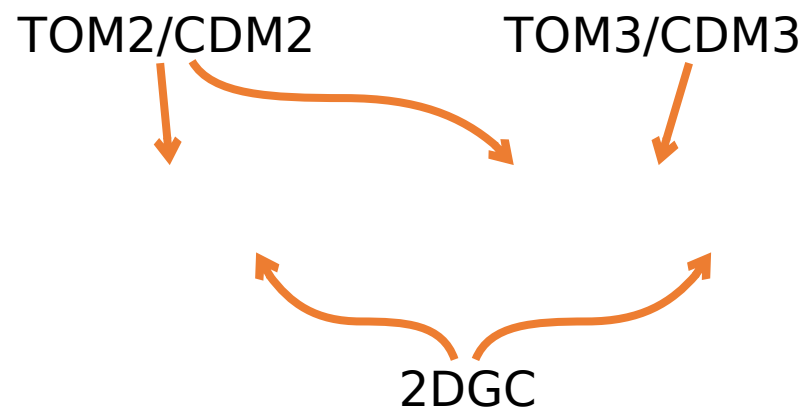
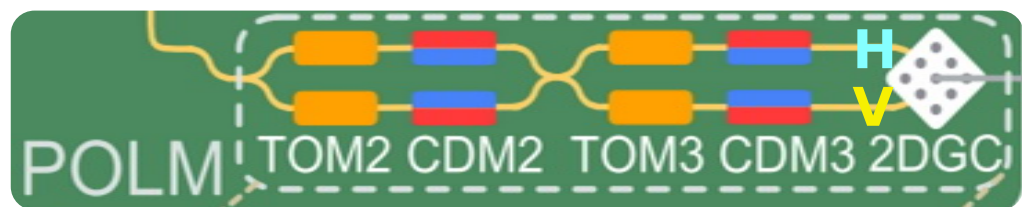

Ideal polarization modulation

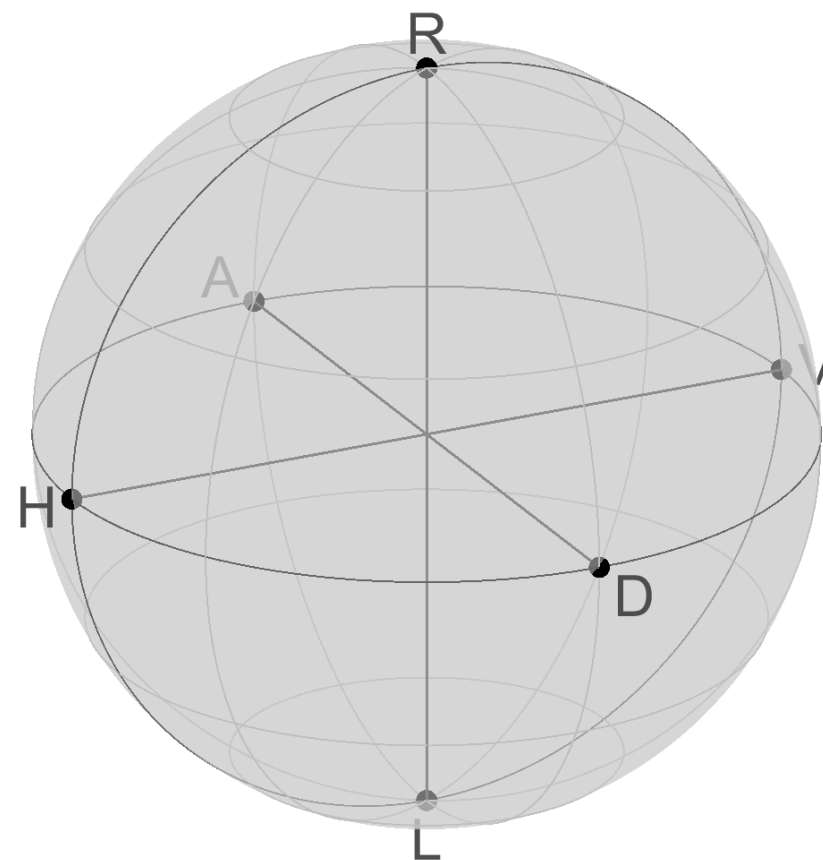

Ideal polarization states

Polarization modulation method

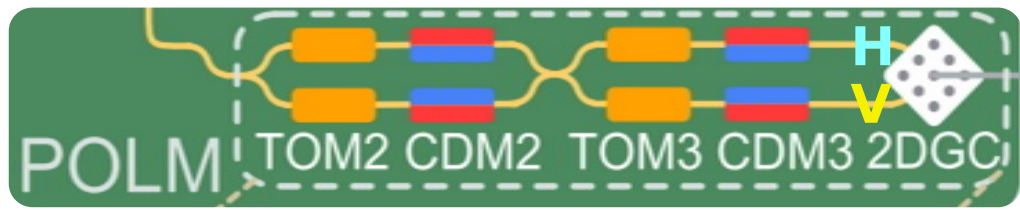

Imperfection:

- 2D Grating Coupler:
- CDM:

Compensation:

- Tune CDM2 to compensate loss of CDM3

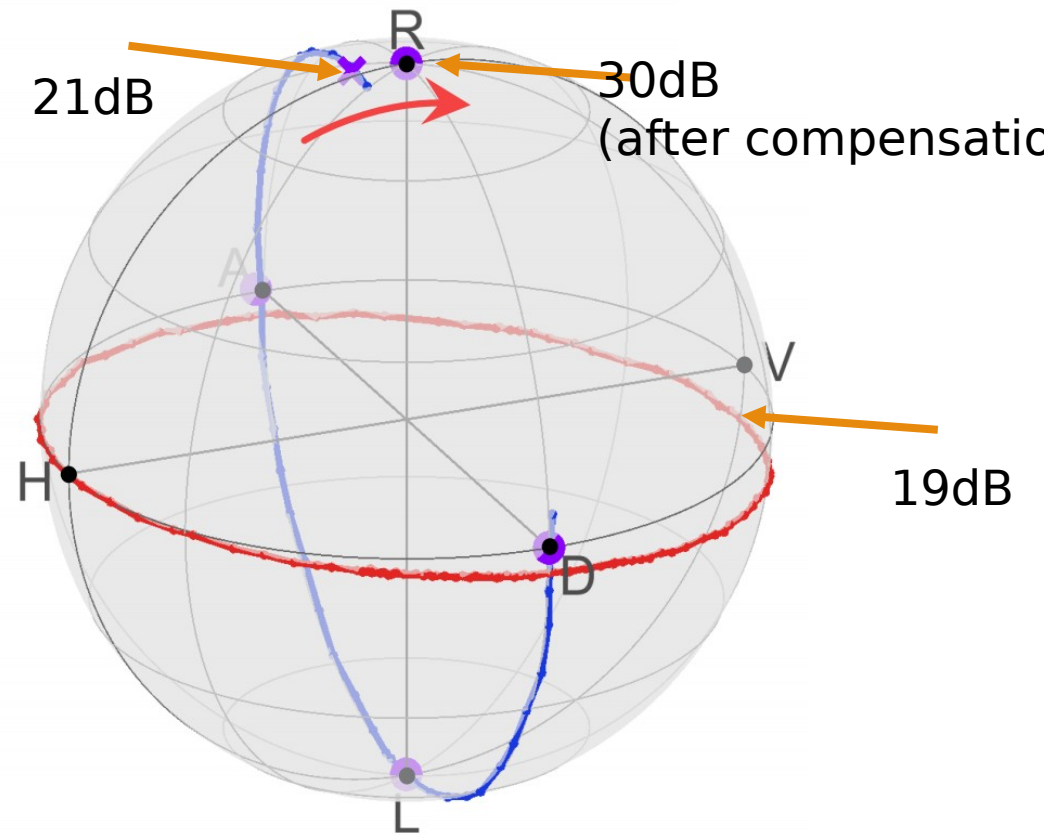

Experimental modulation results

High speed electronics

Commercial solution: AWG+RF amplifier

- Expensive
- AC coupled: Changing one influences other amplitudes

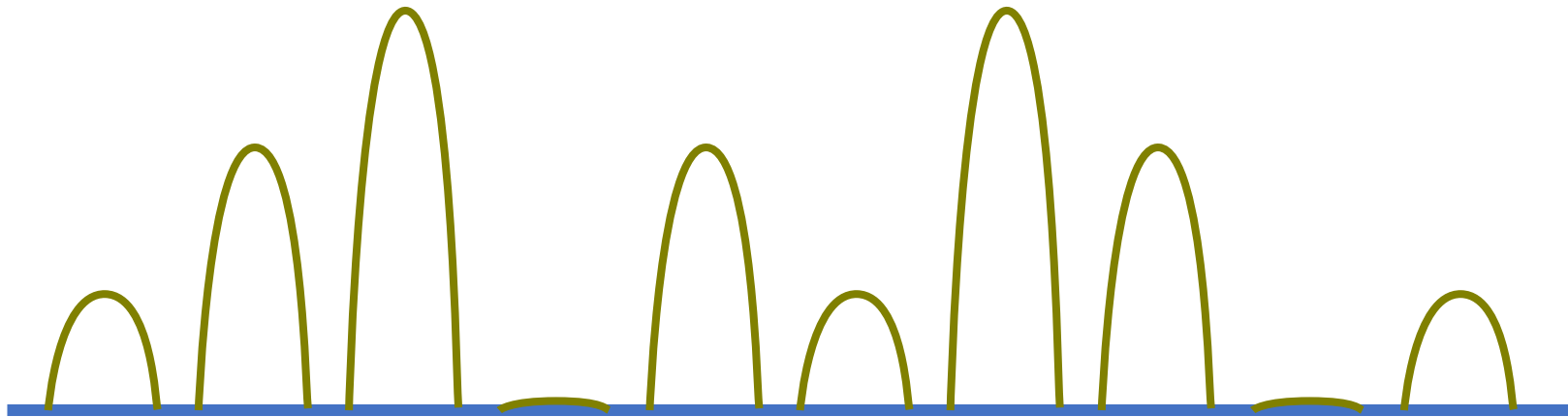

Modulation signals in QKD:

- Randomized
- Multiple amplitudes for decoy intensities and encoding states

High speed electronics

Commercial solution: AWG+RF amplifier

- Expensive
- AC coupled: Changing one influences other amplitudes

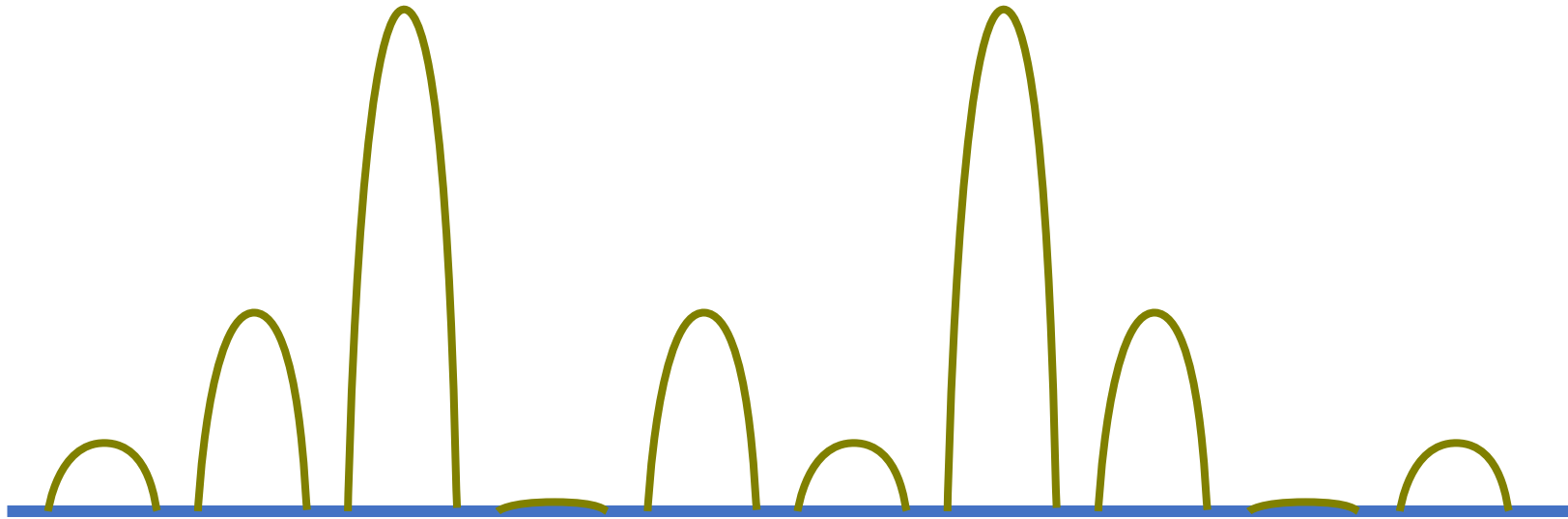

Modulation signals in QKD:

- Randomized
- Multiple amplitudes for decoy intensities and encoding states

High speed electronics

Home-made FPGA electronic board



- 10G Sample/s, 7.5Vpp max
- IM/POLM channel: Four adjustable independent levels
- DC coupled out

Commercial solution: AWG+RF amplifier

- Expensive
- AC coupled: Changing one influences other amplitude

Advantages

- Cost-efficient
- DC coupled: Different amplitudes are uncorrelated and can be independently controlled

High speed electronics

Home-made FPGA electronic board

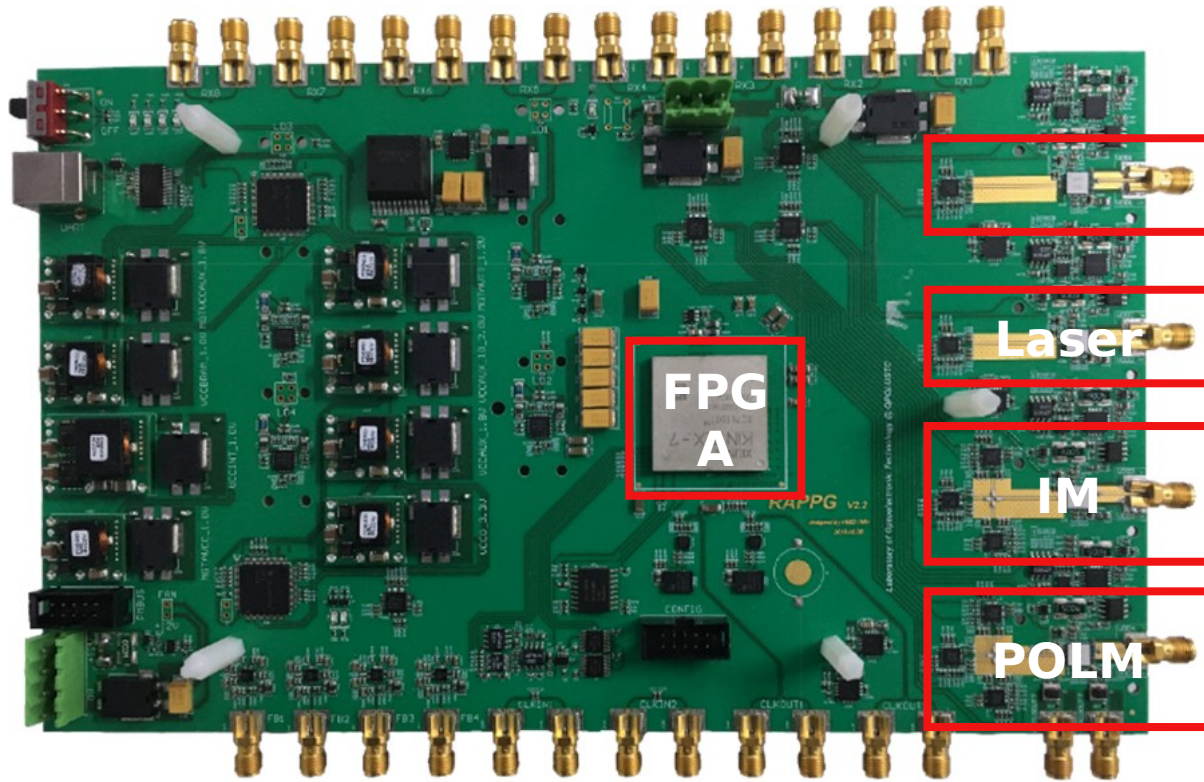

- 10G Sample/s, 7.5Vpp max
- IM/POLM channel: Four adjustable independent levels
- DC coupled out

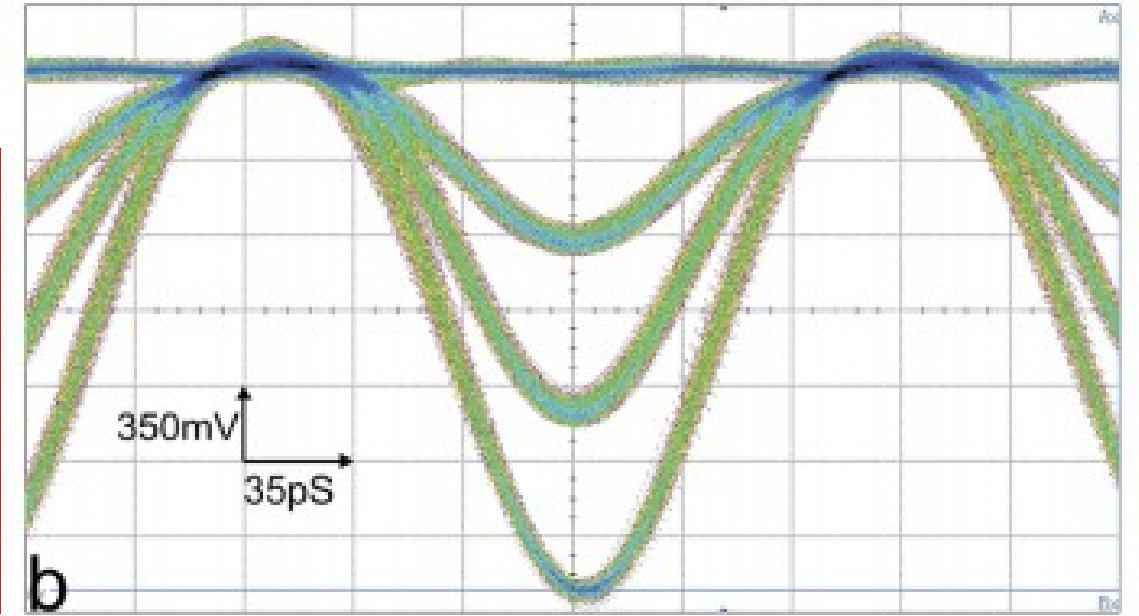

- Three amplitude-modulated and synchronized pulses
- Pulses are combined to generate the desired pattern with multiple amplitudes

1-decoy-intensity 4-encoding-state BB84 Protocol

- **Simple** to perform
- **Security** against general attacks
- The highest **secure key rate(SKR)** in our system

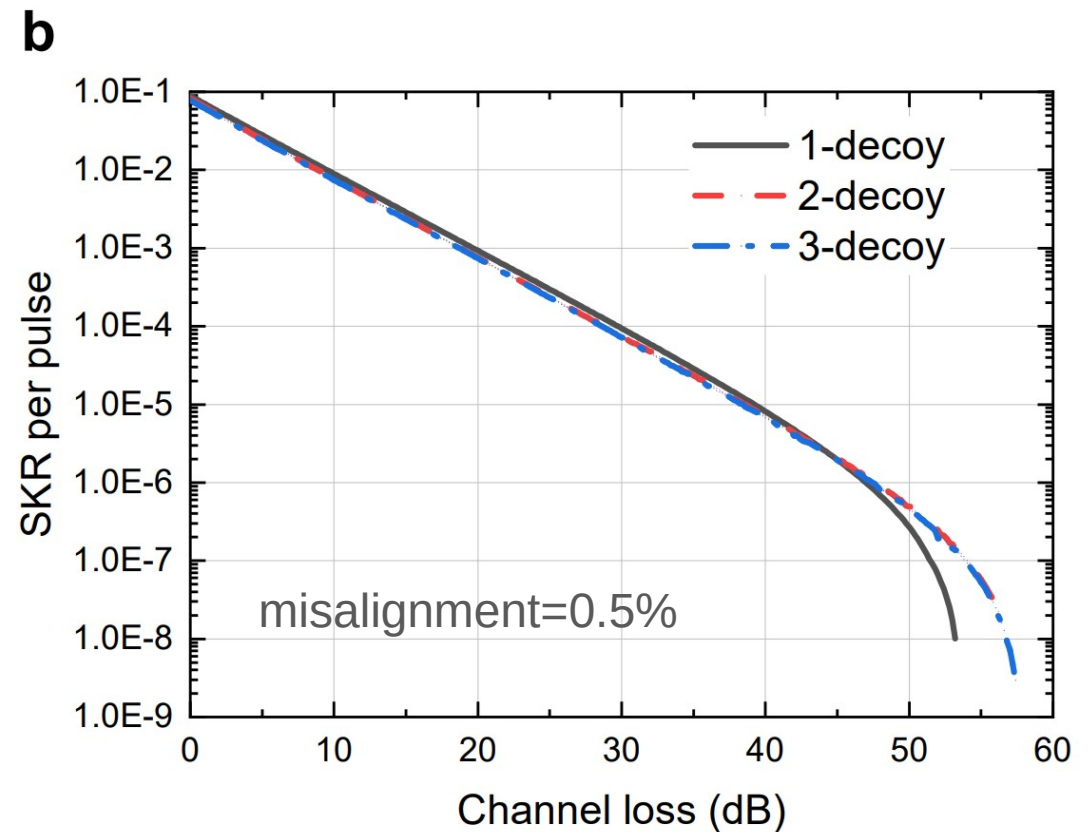
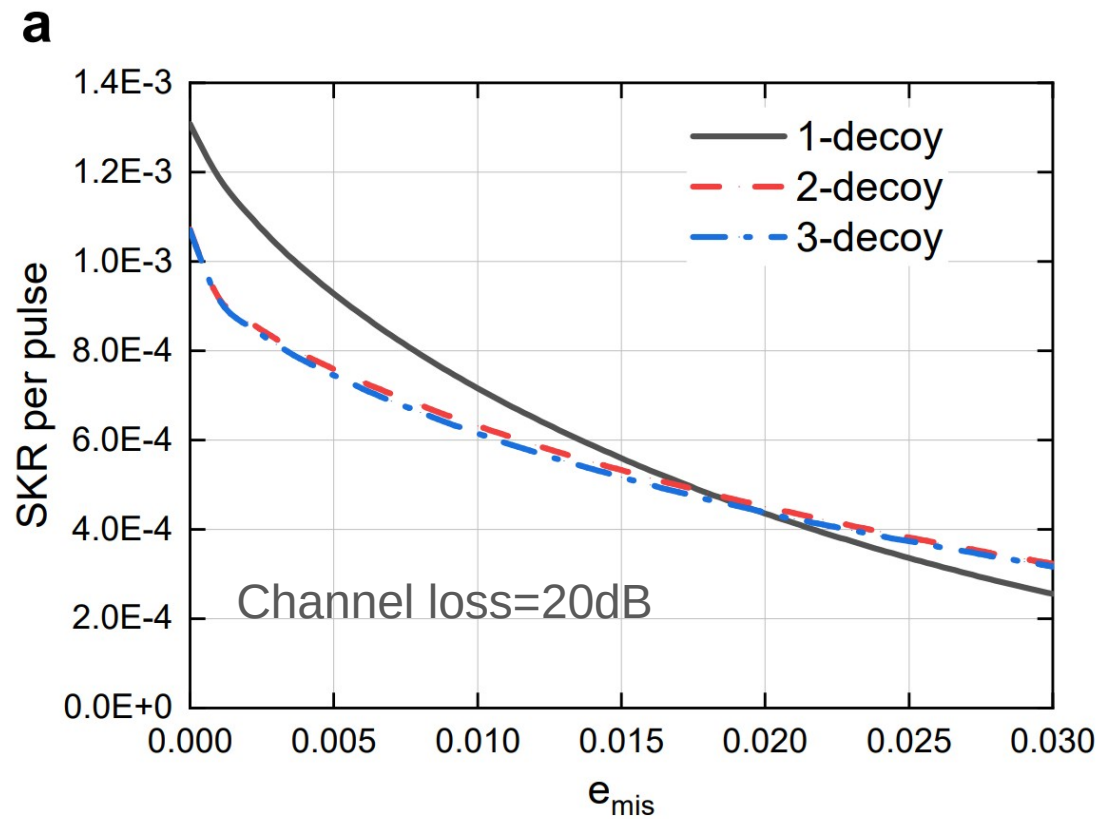

1-decoy-intensity 4-encoding-state BB84 Protocol

1-decoy-intensity Protocol
No need of vacuum states

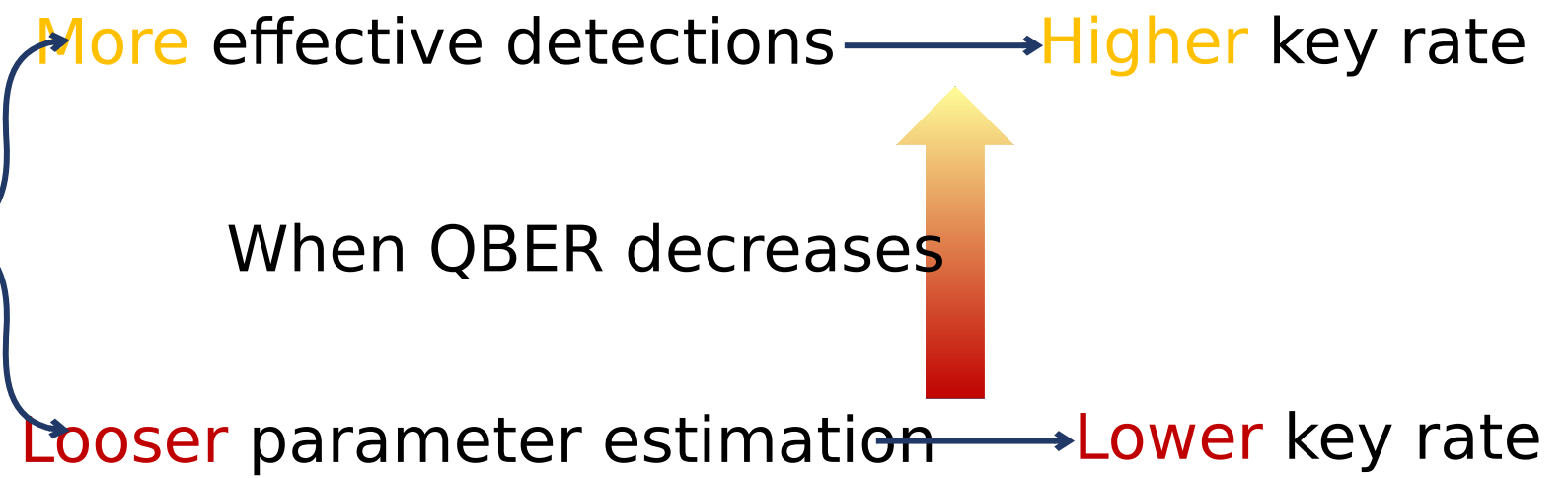

Continuous runs without maintenance

- Time Synchronization + Polarization Feedback
- Continuous run(>7h) with nearly non-degrading secure key rates

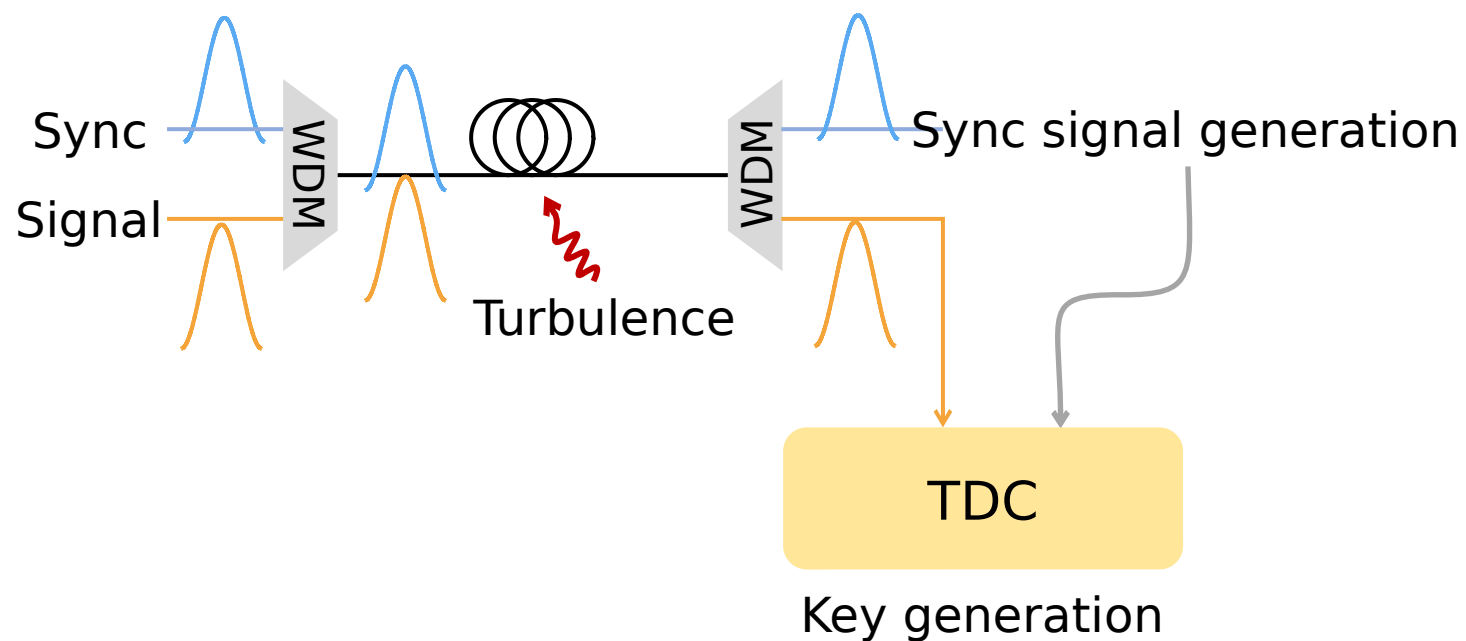

Time Synchronization

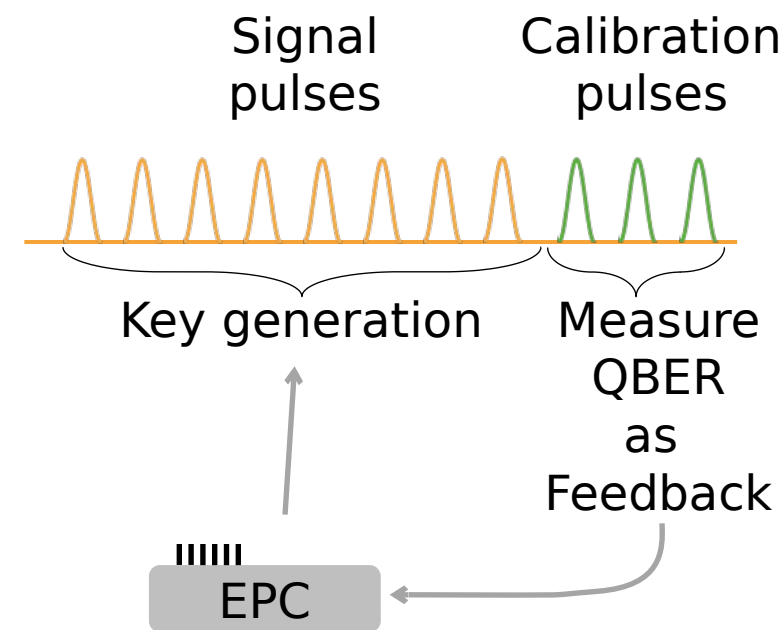

Polarization Feedback

Continuous runs without maintenance

- Time Synchronization + Polarization Feedback
- Continuous run(>7h) with nearly non-degrading secure key rates

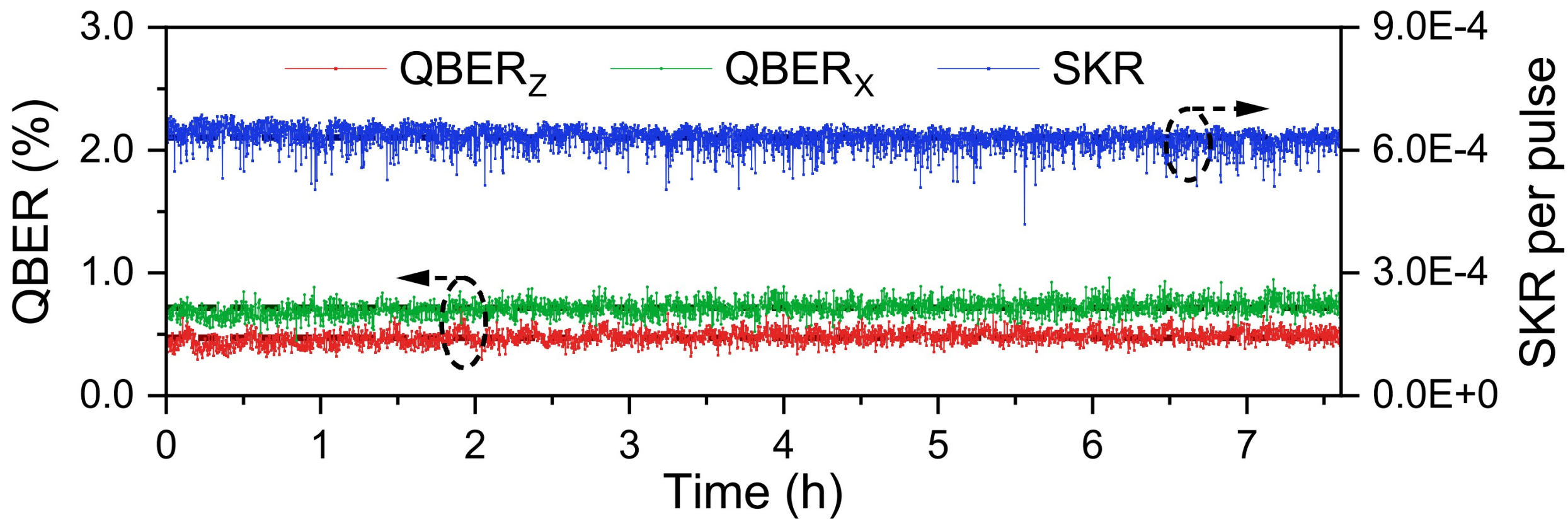

Results

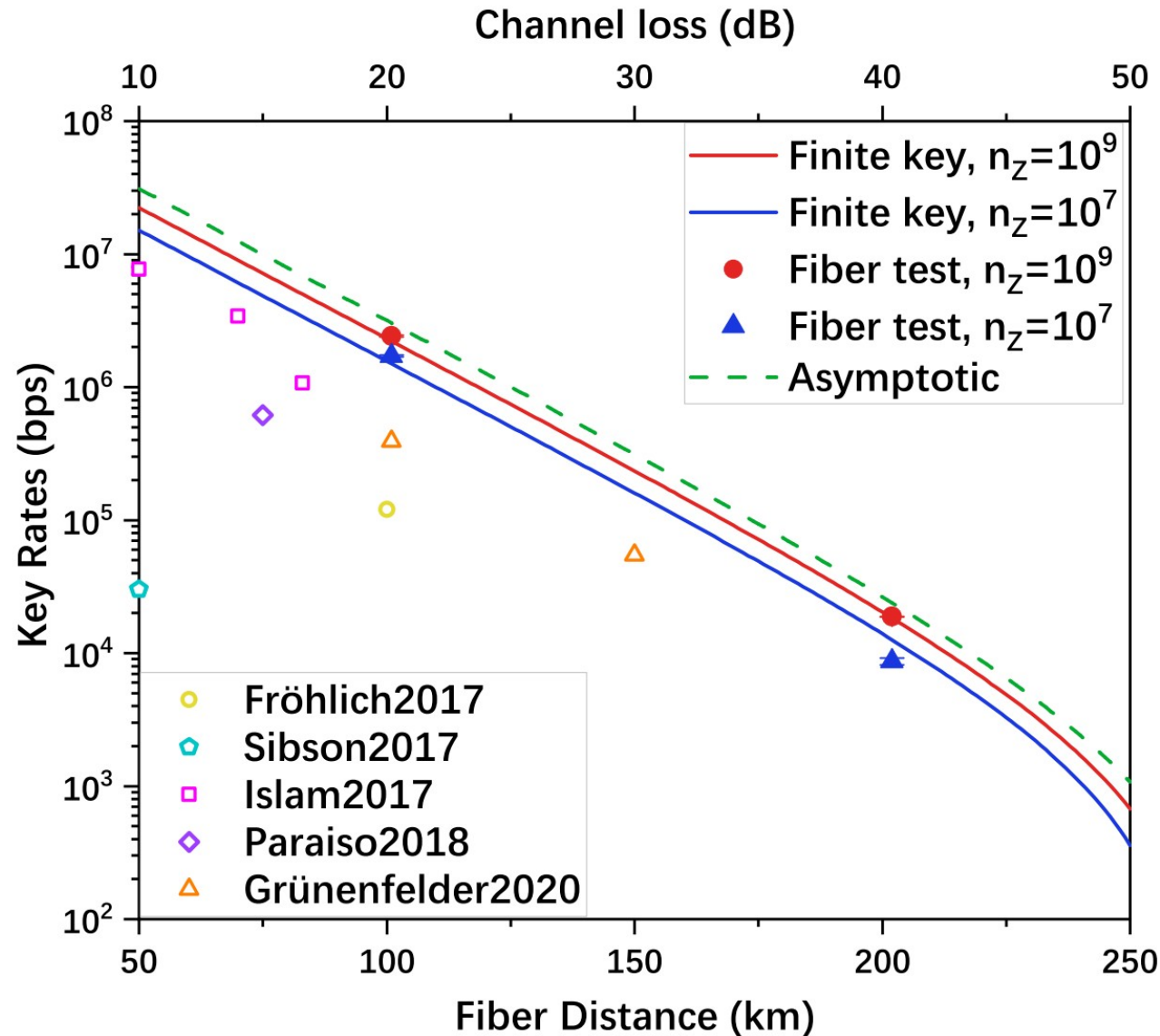

- 2.42 Mbps @ 101 km fiber channel (19.6 dB)

- One of the **highest** rates reported

- Robust, miniaturized and low-cost
- Next Step:

- High-bandwidth QKD network

- Electronics+Photonics Integration

Acknowledgement



Prof. Feihu Xu



Prof. Jian-Wei Pan

Funding



中华人民共和国科学技术部
Ministry of Science and Technology of the People's Republic of China



Our Team

Thank you for your attention!